



[www.jwell.cn](http://www.jwell.cn)

品质卓越 完美如一



info@jwell.cn  
sales@jwell.cn  
13817975703.



版本号Edition No.: 2019.07



PACKAGING & NEW MATERIALS  
EXTRUSION LINE

PACKAGING &  
NEW MATERIAL  
EXTRUSION LINE  
**包装和新材料生产线**

## 吹塑包装设备

### Blow Molding Packaging Equipment

- 01-02 JWZ-EBM系列全电动中空成型机  
JWZ-EBM Full Electric Blow Molding Machine
- 03-06 JWZ-BM02D/05D/12D/20D双工位中空成型机  
JWZ-BM02D/05D/12D/20D Double Station Blow Molding Machine
- 07-08 JWZ-BM30/50/100 中空成型机  
JWZ-BM30/50/100 Blow Molding Machine
- 09-10 JWZ-BM160/230中空成型机  
JWZ-BM160/230 Blow Molding Machine
- 11-12 JWZ-BM500/1000中空成型机  
JWZ-BM500/1000 Blow Molding Machine
- 13-14 JWZ-BM500F/1000F中空成型机  
JWZ-BM500F/1000F Blow Molding Machine

## 包装片材设备

### Packaging Sheet Equipment

- 15-16 PET/PLA/CPLA环保片材生产线  
PET/PLA/CPLA Environmental-Friendly sheet production line
- 17-18 PP/PS片材生产线  
PP/PS sheet production line
- 19-20 PP聚丙烯石粉片材生产线  
PP+Stone Powder sheet production line
- 21-22 PP、EVA、EVOH、PS、PE多层共挤阻隔片材生产线  
PP、EVA、EVOH、PS、PE multi layers co-extrusion barrier sheet production line
- 23-24 PVC透明片材生产线  
PVC transparent sheet production line
- 25-26 PP蜂窝板生产线  
PP honeycomb board production line
- 27-28 PP/PE中空格子板生产线  
PP/PE hollow sheet production line
- 29-30 PC/PMMA/GPPS/ABS塑料片板材生产线  
PC/PMMA/GPPS/ABS plastic sheet/plate production line

## 新材料类片材薄膜生产线

### New Material Sheet Equipment

- 31-32 TPU高低温薄膜、弹性膜生产线  
TPU Transparent Film、Hot Melt Film Extrusion Line
- 33-34 TPU透明薄膜、热熔胶膜生产线  
TPU High-low Temperature、High-elastic Film Co-extrusion Line
- 35-36 薄膜拉伸生产线  
Stretch Film Extrusion Line
- 37-38 EVA/POE/PVB/SGP胶膜生产线  
EVA/POE/PVB/SGP Film Extrusion Line
- 39-40 LFT/CFP/FRP/CFRT连续纤维增强复合材料生产线  
LFT/CFP/FRP/CFRT continuous fiber reinforced composite production line
- 41-42 PE石头纸生产线  
PE Stone Paper Sheet Line
- 43-44 TPO+PP发泡复合片材生产线  
TPO+PP Foam Composite Sheet Production Line
- 45-46 ASA薄膜生产线  
ASA Film Extrusion Line

## 模具、换网器、计量泵、辊筒

### T-die, Screen Changer, Gear Pump, Roller

- 47-48 狭缝涂布模头  
Slot Coating Dies
- 49-50 薄膜模头系列  
Film Die Series
- 51-52 片材模头系列  
Sheet Die Series
- 53-54 板材模头系列  
Plate Die Series
- 55-56 多层共挤分配器  
Multi-layer Co-extrusion Distributor
- 57-60 液压换网系统  
Hydraulic Screen Changer System
- 61-62 熔体计量泵  
Plastic Melt Measuring Gear Pump
- 63-64 镜面辊、花纹辊  
Super Mirror Roller, Embossing Roller
- 65-65 电磁加热辊筒  
Electromagnetic Heating Roller
- 66-66 光学膜用途微结构辊  
Micro-Structure Roller for Optical Film & Sheet
- 67-68 流延膜用辊筒  
Casting Film Roller

## JWZ-EBM系列全电动中空成型机

### JWZ-EBM Full Electric Blow Molding Machine

#### 全电动中空成型机

- 适用于食品、医疗、医药、卫生等包装
- 采用全伺服电机驱动，节能达30%左右
- 无漏油污染，噪音低
- 更加稳定，精度更高，定位更准，运行速度更快，效率更高

#### Fully Electric Blow molding machine

- Suitable for food, medical treatment, medicine and sanitary packing
- Adopt fully servo driving motor, saving power about 30%
- No oil leakage pollution, low noise
- More stable, higher precision, more accurate positioning, faster running speed and higher efficiency



#### 主要技术参数 Technical parameters

名称	Model	Unit	EBM05D	EBM12D	EBM20D
制品最大容积	Max product volume	L	5	12	20
机器空循环	Dry cycle	Pc/h	700*2	600*2	600*2
机头结构	Die head structure		连续式 Continuous type		
主螺杆直径	Main screw diameter	mm	75	90	90
最大塑化能力	Max plasticizing capacity (PE)	kg/h	90	160	160
绞料电机功率	Driving motor	Kw	30	45	45
锁模力	Clamping force	KN	120	240	300
模板开距	Space between platen	mm	2*100	2*120	2*120
模板尺寸	Platen size W*H	mm	400*380	500*400	750*400
最大模具尺寸	Max.mould size	mm	400*380	500*400	750*400
移模行程	Platen moving stroke	mm	520	650	850

注：以上所列资料仅供参考，可根据客户要求量身定制。  
Note: Informations listed above are for reference only, the production line can be designed by customer's requirements.



# JWZ-BM05D/12D/20D双工位中空成型机

## JWZ-BM05D/12D/20D Double Station Blow Molding Machine

### 性能和优点

- 适用于生产1L~5L各种规格的机油壶、润滑油壶、冷却水箱
- 可选配多层共挤
- 可选配液位线挤出
- 按照制品规格大小，选配多模头挤出系统
- 按照原料情况，可选配JW-DB板式单工位液压换网系统
- 按照客人要求、选配在线去飞边、在线飞边输送、在线成品输送等

### Performance and advantages

- Suitable for producing 1-5L different size of gear oil bottle, lubrication oil bottle, cooling water tank etc.
- Optional multi-layer co-extrusion.
- Optional view strip line system.
- According to the product size,select different cavity of die head.
- According to the different material,optional JW-DB single station hydraulic screen-exchanger system.
- According to customer's requirement,optional auto-deflashing on line,scrap conveying on line,finished product conveying on line.



### 主要技术参数 Technical parameters

名称	Model	Unit	BM05D	BM12D	BM20D
制品最大容积	Max product volume	L	5	12	20
机器空循环	Dry cycle	Pc/h	700*2	600*2	600*2
机头结构	Die head structure		连续式 Continuous type		
主螺杆直径	Main screw diameter	mm	75	90	90
最大塑化能力	Max plasticizing capacity (PE)	kg/h	90	160	160
绞料电机功率	Driving motor	Kw	30	45	45
油泵电机功率	Oil pump motor power	Kw	11	15	15
锁模力	Clamping force	KN	70	120	160
模板开距	Space between platen	mm	150-510	240-640	280-680
模板尺寸	Platen size W*H	mm	400*400	450*500	500*520
最大模具尺寸	Max.mould size	mm	410*400	500*520	560*520
移模行程	Platen moving stroke	mm	450/520	600/650	650
机头加热功率	Heating power of die head	Kw	7.5	10	12.5
机器外形尺寸	Machine dimension L*W*H	m	3.7*3.1*2.7	4.2*3.2*3.0	4.3*3.2*3.1
机器总重量	Machine weight	T	8.5	12	14
装机总功率	Total power	Kw	60	90	93

注：以上所列资料仅供参考，可根据客户要求量身定制。  
Note: Informations listed above are for reference only, the production line can be designed by customer's requirements.

# JWZ-BM02D/05D/12D/20D双工位中空成型机

## JWZ-02D/05D/12D/20D Double Station Blow Molding Machine

### 性能和优点

- 可选配珠光层共挤出系统
- 按照制品规格大小，选配多模头挤出系统
- 按照原料情况，可选配JW-DB板式单工位液压换网系统
- 按照客人要求，选配在线去飞边、在线飞边输送、在线成品输送等

### Performance and advantages

- Optional pearly lustre layer co-extrusion system.
- According to the product size,select different cavity of die head.
- According to the different material,optional JW-DB single station hydraulic screen-exchanger system.
- According to customer's requirement.optional auto-deflashing on line,scrap conveying on line,finished product conveying on line and others.



### 主要技术参数 Technical parameters

名称	Model	Unit	BM02D	BM05D	BM12D	BM20D
制品最大容积	Max product volume	L	2	5	12	20
机器空循环	Dry cycle	Pc/h	900*2	700*2	600*2	600*2
机头结构	Die head structure		连续式 Continuous type			
主螺杆直径	Main screw diameter	mm	65	75	90	90
最大塑化能力	Max plasticizing capacity (PE)	kg/h	70	90	160	160
绞料电机功率	Driving motor	Kw	22	30	45	45
油泵电机功率	Oil pump motor power	Kw	7.5	11	15	15
锁模力	Clamping force	KN	40	70	120	160
模板开距	Space between platen	mm	138-368	150-510	240-640	280-680
模板尺寸	Platen size W*H	mm	286*330	400*400	450*500	500*520
最大模具尺寸	Max.mould size	mm	300*350	410*400	500*520	560*520
移模行程	Platen moving stroke	mm	420	450/520	600/650	650
机头加热功率	Heating power of die head	Kw	6	7.5	10	12.5
机器外形尺寸	Machine dimension L*W*H	m	3.0*1.9*2.4	3.7*3.1*2.7	4.2*3.2*3.0	4.3*3.2*3.1
机器总重量	Machine weight	T	5	8.5	12	14
装机总功率	Total power	Kw	45	60	90	93

注：以上所列资料仅供参考，可根据客户要求量身定制。  
Note: Informations listed above are for reference only, the production line can be designed by customer' s requirements.



## JWZ-BM30/50/100 中空成型机

### JWZ-BM30/50/100 Blow Molding Machine

#### 性能和优点

- 适用于生产15-100L各种堆码桶、广口桶等化工包装桶
- 采用高产量挤出系统，储料式模头
- 选配液位线挤出系统
- 选配液压伺服控制系统

#### Performance and advantages

- Suitable for producing 15-100L different size jerrycan, open-top barrels and others chemical packaging products.
- Adopt high output extrusion system, accumulating die head.
- Optional view strip line system.
- Optional hydraulic servo control system.



#### 主要技术参数 Technical parameters

名称	Model	Unit	BM30	BM50	BM100
制品最大容积	Max product volume	L	30	50	100
机器空循环	Dry cycle	Pc/h	600	450	360
机头结构	Die head structure		储料式 Accumulating type		
主螺杆直径	Main screw diameter	mm	80	90	100
最大塑化能力	Max plasticizing capacity (PE)	kg/h	120	180	190
绞料电机功率	Driving motor	Kw	37	45	55
储料缸容量	Accumulating volume	L	5.2	6.2	12.8
油泵电机功率	Oil pump motor power	Kw	15	18.5	22
锁模力	Clamping force	KN	280	400	600
模板开距	Space between platen	mm	400-900	450-1200	500-1300
模板尺寸	Platen size W*H	mm	740*740	880*880	1020*1000
最大模具尺寸	Max.mould size	mm	550*650	700*850	800*1200
机头加热功率	Heating power of die head	Kw	20	28	30
机器外形尺寸	Machine dimension L*W*H	m	4.3*2.2*3.5	5.6*2.4*3.8	5.5*2.5*4.0
机器总重量	Machine weight	T	12	13.5	16
装机总功率	Total power	Kw	95	110	135

注：以上所列资料仅供参考，可根据客户要求量身定制。  
Note: Informations listed above are for reference only, the production line can be designed by customer's requirements.

## JWZ-BM160/230中空成型机

### JWZ-BM160/230 Blow Molding Machine

#### 性能和优点

- 适用于生产100-220L广口桶、双“L”环桶等
- 采用高产量挤出系统，储料式模头
- 选配液压伺服控制系统

#### Performance and advantages

- Suitable for producing 100-220L open-top drums, double "L" ring drums.
- Adopt high output extrusion system, accumulating die head.
- Optional hydraulic servo control system.



#### 主要技术参数 Technical parameters

名称	Model	Unit	BM160	BM230
制品最大容积	Max product volume	L	160	230
机器空循环	Dry cycle	Pc/h	300	280
机头结构	Die head structure		储料式 Accumulating type	
主螺杆直径	Main screw diameter	mm	100	120
最大塑化能力	Max plasticizing capacity (PE)	kg/h	240	350
绞料电机功率	Driving motor	Kw	90	132
储料缸容量	Accumulating volume	L	18	24
油泵电机功率	Oil pump motor power	Kw	22	22
锁模力	Clamping force	KN	800	900
模板开距	Space between platen	mm	500-1400	800-1800
模板尺寸	Platen size W*H	mm	1120*1200	1320*1600
最大模具尺寸	Max.mould size	mm	900*1450	1200*1800
机头加热功率	Heating power of die head	Kw	30	36
机器外形尺寸	Machine dimension L*W*H	m	7*3.5*4	8.2*3.5*5.5
机器总重量	Machine weight	T	20	36
装机总功率	Total power	Kw	172	230

注：以上所列资料仅供参考，可根据客户要求量身定制。  
Note: Informations listed above are for reference only, the production line can be designed by customer's requirements.



# JWZ-BM500/1000中空成型机

## JWZ-BM500/1000 Blow Molding Machine

### 性能和优点

- 适用于生产500-1000L大型化工周转桶等
- 采用高产量挤出系统，储料式模头，液压伺服控制系统

### Performance and advantages

- Suitable for producing 500-1000L big size Chemical revolving barrel.
- Adopt high output extrusion system,accumulating type die head,hydraulic servo control system.



### 主要技术参数 Technical parameters

名称	Model	Unit	BM500	BM1000
制品最大容积	Max product volume	L	500	1000
机器空循环	Dry cycle	Pc/h	250	155
机头结构	Die head structure		储料式 Accumulating type	
主螺杆直径	Main screw diameter	mm	100*2	120*2
最大塑化能力	Max plasticizing capacity (PE)	kg/h	400	700
绞料电机功率	Driving motor	Kw	90*2	132*2
储料缸容量	Accumulating volume	L	40	60
油泵电机功率	Oil pump motor power	Kw	40	55
锁模力	Clamping force	KN	1300	1800
模板开距	Space between platen	mm	950-2000	1000-2700
模板尺寸	Platen size W*H	mm	1400*1800	1900*2300
最大模具尺寸	Max.mould size	mm	1200*1920	1750*2200
机头加热功率	Heating power of die head	Kw	50	65
机器外形尺寸	Machine dimension L*W*H	m	104*8.2*6.5	14*12*8.5
机器总重量	Machine weight	T	45	70
装机总功率	Total power	Kw	325	460

注：以上所列资料仅供参考，可根据客户要求量身定制。  
Note: Informations listed above are for reference only, the production line can be designed by customer's requirements.



# JWZ-BM500F/1000F中空成型机

## JWZ-BM500F/1000F Blow Molding Machine

### 性能和优点

- 适用于生产各种规格吹塑托盘
- 选配下包封、制品顶出、抽芯等动作元件
- 采用高产量挤出系统，储料式模头
- 液压伺服控制系统

### Performance and advantages

- Suitable for producing different kinds of pallet.
- Optional bottom sealing, product eject, core-pulling movement elements.
- Adopt high output extrusion system, accumulating die head.
- Hydraulic Servo control system.



### 主要技术参数 Technical parameters

名称	Model	Unit	BM500F	BM1000F
制品最大容积	Max product volume	L	500	1000
机器空循环	Dry cycle	Pc/h	250	155
机头结构	Die head structure		储料式 Accumulating type	
主螺杆直径	Main screw diameter	mm	120/135	120*2
最大塑化能力	Max plasticizing capacity (PE)	kg/h	400	700
绞料电机功率	Driving motor	Kw	132/160	132*2
储料缸容量	Accumulating volume	L	45/60	75/90
油泵电机功率	Oil pump motor power	Kw	40	55
锁模力	Clamping force	KN	1300	1800
模板开距	Space between platen	mm	950-2000	1000-2700
模板尺寸	Platen size W*H	mm	1400*1800	1900*2300
最大模具尺寸	Max.mould size	mm	1200*1920	1750*2200
机头加热功率	Heating power of die head	Kw	50	65
机器外形尺寸	Machine dimension L*W*H	m	10.5*8.2*6.5	14*12*8.5
机器总重量	Machine weight	T	45	70
装机总功率	Total power	Kw	325	460

注：以上所列资料仅供参考，可根据客户要求量身定制。  
Note: Informations listed above are for reference only, the production line can be designed by customer's requirements.

## PET/PLA/CPLA环保片材生产线 PET/PLA/CPLA Environmental Sheet Extrusion Line

双螺杆免干燥排气型PET/PLA片材生产线具有低能耗、工艺简单，设备使用维护方便。其特有的螺杆组合结构有效的减少了PET/PLA树脂的粘度降。对称式薄壁型辊筒提高了冷却效率同时提升了产能和片材品质。多组分喂料装置可合理的控制新料、回料、色母等的比例，所生产的片材可用于吸塑印刷包装等领域。

develops the parallel twin screw extrusion line for PET/PLA sheet, this line equipped with degassing system, and no need drying and crystallizing unit. The extrusion line has the properties of low energy consumption, simple production process and easy maintenance.



### 主要技术参数 Technical parameters

机型	挤出机规格	制品厚度	主电机功率	最大挤出产量
Model	Extruder model	Products thickness(mm)	Main motor power(kw)	Max extrusion Capacity(kg/h)
共挤线 Multi layer	JWE75/40+JWE52/40-1000	0.15-1.5	132/55	500-600
单层线 Single layer	JWE75/40-1000	0.15-1.5	160	450-550
高效Highly-efficient	JWE95/44+JWE65/44-1500	0.15-1.5	250/75	1000-1200

注：以上所列资料仅供参考，可根据客户要求量身定制。  
Note: Informations listed above are for reference only, the production line can be designed by customer's requirements.





## PP/PS片材生产线 PP/PS Sheet Extrusion Line

研制开发的PP/PS片材生产线，用于生产多层复合环保片材，该片材主要用于吸塑成型各类食品容器和包装，如：托盘、面碗、饭盒、糕盒、水果盘等。该设备可有效的利用石粉比例，既降低片材原料成本，又提高片材的可降解性并保证片材的综合物理性能和后续可加工性能。

Developed by Jwell company, this line is for producing multi-layer environmental-friendly sheet, which is widely used for vacuum forming, green food container and package, different kinds of food packaging container, such as: salver, bowl, canteen, fruit dish, etc. Adopting maxim talc percentage in the sheet production, either customer will be able to reduce the cost of the sheet or increase the sheet degraion character as well as gaining good physical properties and further processing abilities.

### 主要技术参数 Technical parameters

机型 Model	JWS150/120/90-1800	JWS150/60-1200	JWS130/60-1000	JWS120-1000	JWS100-800
片材宽度 Width	1500mm	1000mm	900mm	800mm	600mm
片材厚度 Thickness	0.3-2mm	0.3-2mm	0.3-2mm	0.2-2mm	0.1-0.8mm
生产能力 Capacity	1000-1200kg/h	700-800kg/h	550-600kg/h	400-500kg/h	300-350kg/h

注：以上所列资料仅供参考，可根据客户要求量身定制。  
Note: Informations listed above are for reference only, the production line can be designed by customer' s requirements.



## PP聚丙烯石粉片材生产线 PP+Stone Powder Sheet Extrusion Line

### PP+石粉片材生产线

金纬机械研制开发的PP+石粉环保片材生产线，采用三台挤出机三层或四层共挤法，选用金纬新设计的PP+石粉专用排气式螺杆结构，PLC电脑控制和自动测厚仪跟踪检测，从而有效利用石粉比例，在降低片材原料成本的基础上，又确保片材的综合物理性能和后续可加工性能，使生产线产能指数达到良好状态，是目前国内先进的片材机组之一。

### PP+Stone sheet extrusion line

It developed by Jwell company uses the three extruders for 3 or 4 layers co-extrusion. This line adopts the Jwell latest designed PP+CaCo3 vented screw and the PLC computer controlling device and automatically thickness detection device so that the machine can maximize the percentage of the CaCo3 in the sheet production to reduce the cost of the sheet and the sheet produced can gain the good physical properties and further processing abilities. It is the most advanced sheet machine in China.

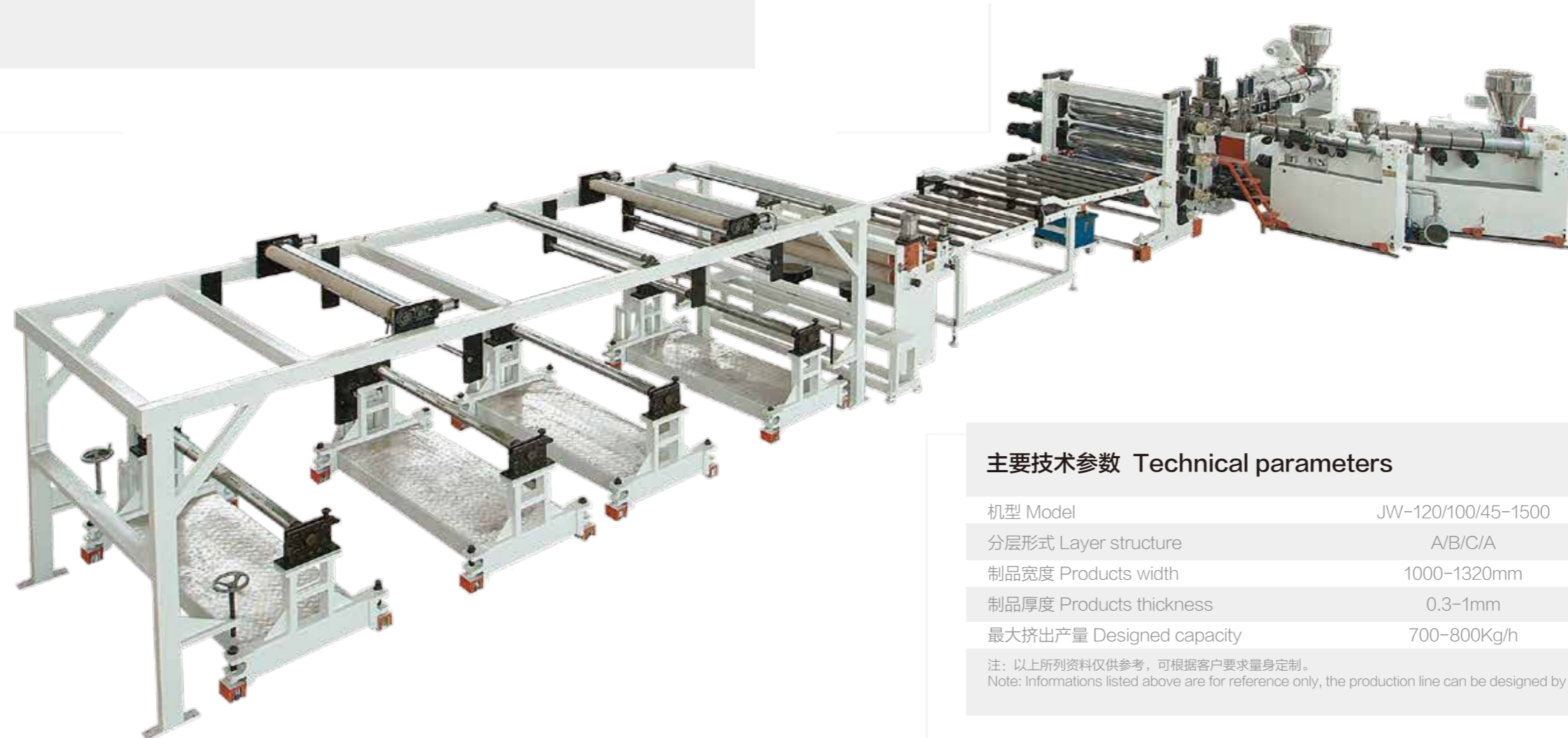
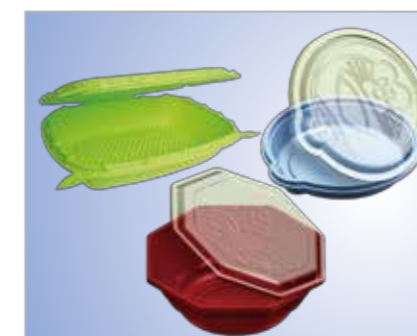

### 主要技术参数 Technical parameters

机型 Model	JW-120/100/45-1500	JW-90/95/110/65
分层形式 Layer structure	A/B/C/A	A/B/C/D
制品宽度 Products width	1000-1320mm	1200-1500mm
制品厚度 Products thickness	0.3-1mm	0.3-1.5mm
最大挤出产量 Designed capacity	700-800Kg/h	1000-1200Kg/h

注：以上所列资料仅供参考，可根据客户要求量身定制。  
Note: Informations listed above are for reference only, the production line can be designed by customer's requirements.



# PP、EVA、EVOH、PS、PE多层共挤阻隔片材生产线

## PP, EVA, EVOH, PS and PE Multi-Layer Sheet Co-Extrusion Line

### PP、EVA、EVOH、PS、PE多层共挤阻隔片材生产线

由于市场对产品越来越苛刻的要求，上海金纬开发了先进的五层对称和七层非对称分配技术，使该设备生产出的产品获得了更优异的阻隔性能。

### PP, EVA, EVOH, PS and PE multi-layer sheet co-extrusion line

To meet market's high request on products, Shanghai JWELL develops advanced technology of five layer symmetrical distribution and seven layer asymmetrical distribution, which makes the sheets having better barrier performance.

### PP/EVA/EVOH/EVA/PP五层或七层共挤复合高阻隔保鲜包装片材

是具有良好的阻气性、阻湿性，是气体阻隔性能良好的一种塑料包装材料。主要应用于果冻包装，高档肉食品、快餐米饭等食品包装，药品、化妆品等包装。

### PP/EVA/EVOH/EVA/PP five or seven multi-layer co-extrusion high barrier fresh keeping sheet

has the excellent anti-oxygen and anti-humidity features. It is one of the best barrier packing materials. Mainly used for Jelly packing, meat packing, snack food packing, medicine and cosmetic packing and so on.

### 主要技术参数 Technical parameters

机型 Model	JW100/45/45-1000	JW120/45/30/65-1200	JW150/45/45-1500
适用原料 Suitable material	PP、PE、PET、PS		
片材宽度 Width	800mm	1000mm	1200mm
片材厚度 Thickness	0.5-2mm	0.5-2mm	0.5-2mm
生产能力 Capacity	300kg/h	400kg/h	650kg/h
设计线速度 Designed line speed	15m/min	20m/min	30m/min
辊筒直径 Calendar diameter	Ø400mm	Ø500mm	Ø600mm

注：以上所列资料仅供参考，可根据客户要求量身定制。  
Note: Informations listed above are for reference only, the production line can be designed by customer's requirements.

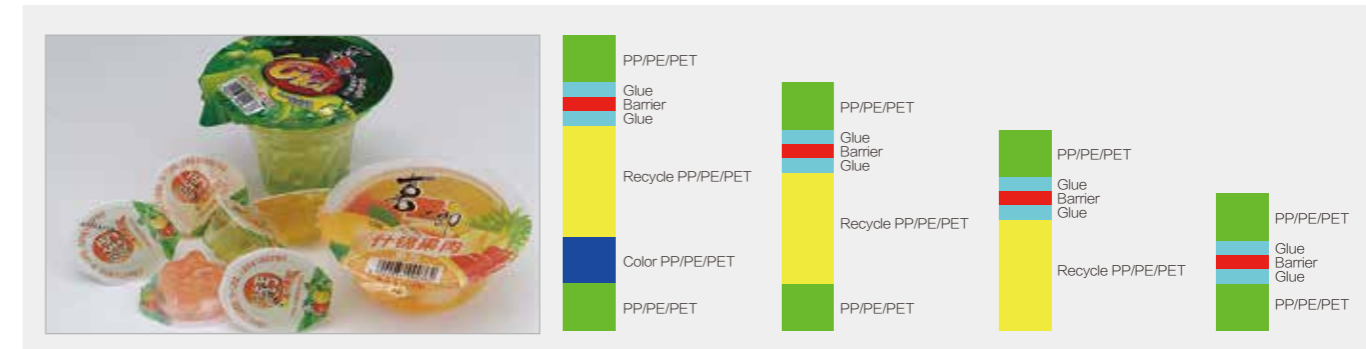
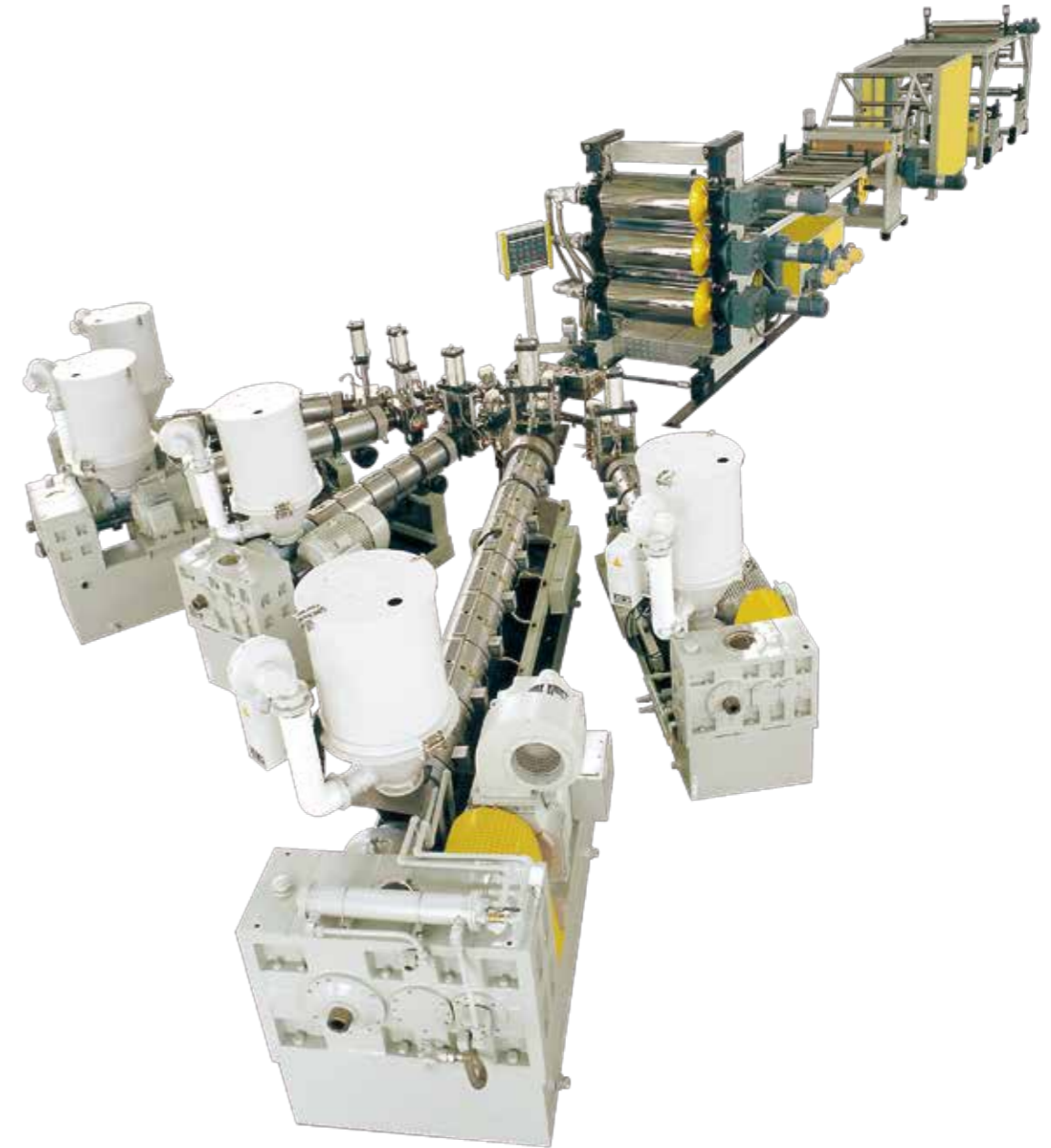

## PVC透明硬片/PVC装饰片生产线

### PVC Transparent Rigid Sheet and PVC Decoration Sheet Extrusion Line

#### PVC挤出透明硬片生产线

PVC挤出透明片材具有阻燃自熄、质优价廉、透明度高、表面光泽好、晶点少、水纹小、耐冲击性强且易于成型等特点，广泛应用于各类工具、玩具、电子、食品、医药、服装等行业的吸塑、折盒、包装等。

#### PVC transparent rigid sheet extrusion line

PVC transparent sheet have many advantages of fire-resistance, high quality, low cost, high transparent, good surface, no spot, less water wave, high strike resistance, easy to mould and etc. It is applied to different kinds of packing, vacuuming and case, such as tools, toys, electics, food, medicine and clothes.



#### PVC装饰片生产线

PVC装饰片主要用于酒店、餐馆、办公室、厨房灯地方的内外墙装饰。

#### PVC decoration plate line:

Product application: For decoration in hotel, restaurant, office, inner wall of villa, kitchen, toilet and it can be used or outside wall decoration, ceiling, table cloth, flooring and etc.



#### 主要技术参数 Technical parameters

机型	挤出机规格	制品宽度	制品厚度	主电机功率	设计挤出产量
Model	Extruder model	Products width(mm)	Products thickness(mm)	Main motor power(kw)	Designed extrusion output(kg/h)
SJZ80/156-1500	SJZ80/156	1220	0.2-3.0	75	350
SJZ92/188-2200	SJZ92/188	2000	1.0-3.0	110	550

注：以上所列资料仅供参考，可根据客户要求量身定制。  
Note: Informations listed above are for reference only, the production line can be designed by customer's requirements.



# PP蜂窝板生产线

## PP Honeycomb Board Extrusion Line

### 产品主要用途 Main application

- 1.应用于乘用车的行李箱盖板、行李箱隔板、行李箱地毯基板、侧围装饰板、顶棚等内饰部位；  
Used for car trunk cover board, trunk clapboard, trunk carpet substrate, side wall decoration board, ceiling etc. interior place.
- 2.应用于制作各种高强度包装箱。  
Used for manufacturing different kinds of high strength packing box.

PP蜂窝板通过挤出法一次成型的三层夹心板材，两面为较薄的面层，中间为蜂窝状结构；根据蜂窝的结构可以分为单层板、双层板。  
PP蜂窝板也可一次成型双面贴布、覆皮，具有轻质高刚、无毒环保减震耐寒、隔音保温、防潮隔热等优点。

PP honeycomb board through extrusion method made three layers sandwich board of one time forming, two sides is thin surface, middle is honeycomb structure; According to honeycomb structure can divide into single layer, double layer board.  
PP honeycomb board also can one time forming, coat fabric at two sides, leather, with light weight and high strength, non-toxic, environment, shake absorption and cold-resistant, soundproof& heat preservation, moistureproof& heat insulation etc. advantage.



### 主要技术参数 Technical parameters

机型	适用原料	制品宽度	制品厚度	设计挤出产量
Model	Suitable material	Products width(mm)	Products thickness(mm)	Capacity(kg/h)
JWS75/75/75	PP	1200-1600	2-12	350-450
JWS100/100/100	PP	1200-2000	2-20	600-700

注：以上所列资料仅供参考，可根据客户要求量身定制。  
Note: Informations listed above are for reference only, the production line can be designed by customer's requirements.

## PP/PE中空格子板生产线

### PP/PE Plastic Hollow Cross Section Plate Extrusion Line

#### PP格子板应用

- PP中空格子板因具有材质轻，强度高，防潮。
- 良好的环保性能和二次加工性能，可加工成周转箱，包装箱等。

#### PP Hollow Plate Application

- The PP hollow cross section plate is light and high strength, moistureproof good environmental protection and refabrication performance.
- Can be processed into the reusable container, packing case, clapboard, backing plate and culet.

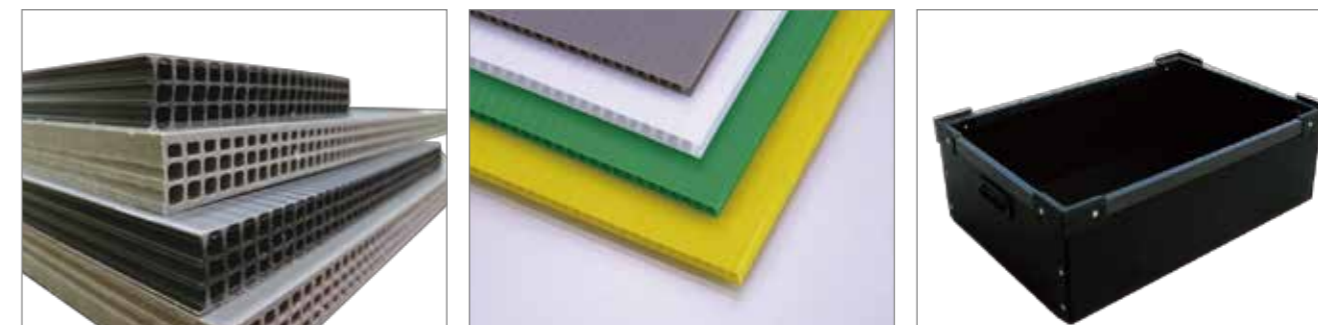

#### 主要技术参数 Technical parameters

挤出机规格	制品宽度	制品厚度	最大挤出产量
Model	Products width(mm)	Products thickness(mm)	Designed capacity(kg/h)
JWS120	1200-2100	2-8	350
JWS150	1200-2600	2-8	500
JWS100+JWS65	915	12-16	400
JWS150+JWS90	2000	12-16	600

注：以上所列资料仅供参考，可根据客户要求量身定制。  
Note: Informations listed above are for reference only, the production line can be designed by customer's requirements.





## PC/PMMA/GPPS/ABS塑料片板材生产线 PC/PMMA/GPPS/ABS Plastic Sheet & Plate Extrusion Line



### PC耐力板、波浪板

适用范围：园林、游艺场所奇异装饰及休息场所的廊亭；商业建筑的内外装饰品，现代城市楼房的幕墙；航空透明集装箱、摩托车前风挡、飞机、火车、轮船、汽车、汽船、潜艇及玻璃军警盾牌；电话亭、广告路牌、灯箱广告展示展览的布置；高速公路及城市高架路隔音屏障。

### Applicable scope of PC endurance board, PC corrugated sheet

Garden, recreation place, decoration and the corridor pavilion; Internal and external ornaments in the commercial building, curtain wall of the modern urban building; transparent container of aviation, the windscreen before the motorcycle, the plane, the train, the steamer, the submarine, army and police' s shield, the telephone booth, advertising signpost, the advertisement of the lamp houses, the expressway and overhead way of the city partition protective screen.

### ABS、HIPS/GPPS冰箱板 Refrigerator board

主要用于冰箱冰柜门胆、内胆、抽屉、接水盘、饮水机等。  
It has wide application in production of refrigerator door and inner gallbladder, drawers, water dispensers, etc.

### ABS/PMMA复合洁具板 Sanitaryware plate

用于卫浴产品如：浴缸、淋浴房、蒸汽房、洗脸槽。  
It is widely applied in the field of bath products, such as the bathtub, the shower cabinet, the vapor room, washing bowl, etc.

### ABS/PC复合箱包板 Baggage plate

主要用于各种拉杆箱、行李箱、休闲包等箱包。  
It is mainly applied in field of draw-bar boxes, luggage cases, recreation bags, etc.

### ABS、ABS + PC合金料汽车板 Car plate

主要用途：汽车车顶、仪表板；座椅靠板、车门板、窗框；摩托车、沙滩车、代步车、高尔夫球车等外壳。  
It is mainly used in to produce tops of cars and buses, instrument boards, backrest, car doors, window frames, shells of the motorcycles, golf vehicles, etc.

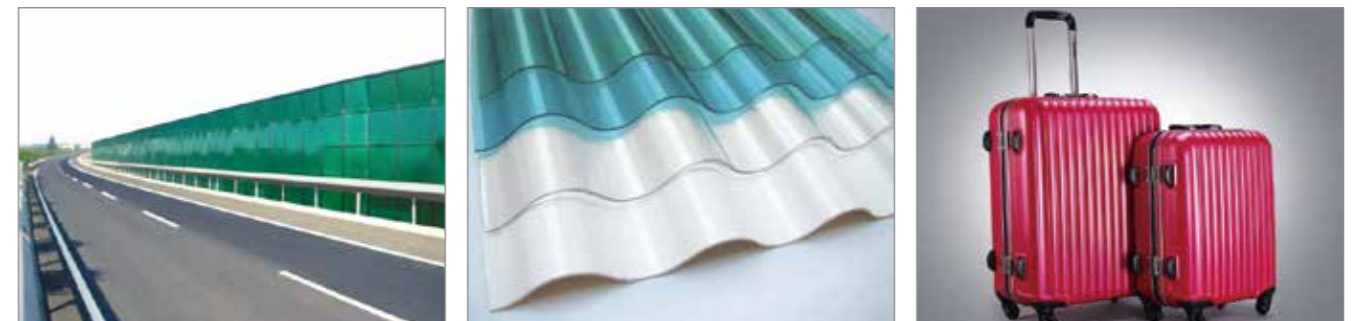

### 主要技术参数 Technical parameters

型号 Model	JWS130/38-2200	JWS120/38-1400
适用原料 Material	PC, PMMA, GPPS, ABS	PC, PMMA, GPPS, ABS
制品宽度 Products Width	2200mm	1400mm
制品厚度 Products Thickness	1.5-10mm	1.5-10mm
挤出机规格 Extruder Specification	Ø130/38; Ø45/30	Ø120/38
最大挤出产量 Capacity (Max.)	550Kg/h	450Kg/h

注：以上所列资料仅供参考，可根据客户要求量身定制。  
Note: Informations listed above are for reference only, the production line can be designed by customer' s requirements.

# TPU透明薄膜、热熔胶膜生产线

## TPU Transparent Film、Hot Melt Film Extrusion Line



拥有卓越的高张力、高拉力、强韧和耐老化的特性  
具有环保无毒、防霉抗菌、耐磨抗腐、生物相容等优良特性  
广泛应用于鞋材、成衣、充气玩具、汽车椅座材料、雨伞、皮箱、皮包等  
且可以应用于防弹玻璃、包装材料。

excellent feature of high tension, high tensile force, good toughness,  
ageing resistance, environmentally non-toxic, antimycotic & antibacteria  
wear and corrosion resistance, biological compatibility.  
It is used widely in the field of shoe, clothes, air-filled toy,

### 主要技术参数 Technical parameters

机型 Model	制品宽度 Products width(mm)	制品厚度 Products thickness(mm)	设计挤出产量 Capacity(kg/h)
JWS120/36	1000-3000	0.02-2.0	200-300
JWS130/36	1000-3000	0.02-2.0	300-400

注：以上所列资料仅供参考，可根据客户要求量身定制。  
Note: Informations listed above are for reference only, the production line can be designed by customer's requirements.





## TPU高低温薄膜、高弹膜生产线 TPU High-low Temperature、High-elastic Film Co-extrusion Line

生产线特点：通过2台或3台挤出机共挤的方式，将不同温度范围和硬度范围的TPU原料，一次性复合挤出成型。相比传统复合工艺，将高温、低温薄膜下线再复合，显得更经济、更环保、更高效。  
制品广泛应用于止水条、鞋材、服装、箱包、文具、体育用品等等。

Features: TPU raw materials with different temperature and hardness ranges are extruded by two or three extruders at one time. Compared with the traditional composite process, it is more economical, more environmentally friendly and more efficient to recombine high-temperature and low-temperature thin films offline.  
Products are widely used in water-proof strips, shoes, clothing, bags, stationery, sports goods and so on.



### 主要技术参数 Technical parameters

机型 Model	制品宽度 Products width(mm)	制品厚度 Products thickness(mm)	设计挤出产量 Capacity(kg/h)
JWS90+JWS100	1000-2000	0.02-0.5	200-250
JWS90+JWS90+JWS90	1000-2000	0.02-0.5	200-300

注：以上所列资料仅供参考，可根据客户要求量身定制。  
Note: Informations listed above are for reference only, the production line can be designed by customer's requirements.

## 薄膜拉伸生产线 Stretch Film Extrusion Line

设备的主要构成：挤出机、模具、铸片、纵向拉伸、横向拉伸、自动收卷和控制系统组成。依托我司先进的整体设计和加工制造能力，研制的拉伸生产线具有以下特点：

- 特殊设计的纵拉辊筒
- 动力传动及控制系统采用国际知名品牌
- 控制系统采用精密PLC程序控制
- 拉伸精度高、速度快、整个机组的运行稳定

我司可根据客户需求，定制设计各类高精度拉伸薄膜机组：

1-10倍拉伸倍率，产品宽度范围500-3000mm，厚度范围0.05-0.3mm。

The equipment is composed by extruder, die head, sheet cast, lognitudinal stretch, transverse stretching, automatic winder and controlling system. Relying on our advanced designing and processing ability, our equipment' s features are:

- Special designed lognitudinal strech roller
- Driving and controlling system are from world famous brand
- Controlling system is from precision PLC program
- High stretch acuracy, high speed, and steady working status

We are able to design equipment as per customer' s request with high acuracy stretch equipment:

1-10 stretching ratio, width range will be 500-3000mm, thickness range will be 0.05-0.3mm.

主要应用于生产PE锂电池隔膜；PP、PE卫材透气膜；  
PP、PE、PET、PS热收缩包装行业等单、双向拉伸薄膜领域。

Stretch film production line is mainly used for PE lithium electric film;  
PP,PE breathable film; PP, PE, PET, PS thermo-shrinkage packing industrial.





## EVA/POE/PVB/SGP胶膜生产线 EVA/POE/PVB/SGP Film Extrusion Line

EVA/POE 胶膜：用于太阳能光伏电站、建筑物玻璃幕墙、汽车玻璃、功能性棚膜、包装膜、热熔胶等各种行业。

EVA/POE film is used in solar photovoltaic power station, building glass curtain wall, automobile glass, functional shed film, packaging film, hot melt adhesive and other industries.

PVB/SGP胶膜：广泛应用于建筑夹层玻璃，汽车夹层玻璃，防弹玻璃，隔音玻璃等。具有很好的安全性，防止玻璃由于外力作用下破碎而碎片溅起伤人；具有隔音性，防紫外线，可以做成彩色或高透明的薄膜。

PVB/SGP film: is widely used in building sandwich glass, car sandwich glass, bulletproof glass, soundproof glass etc. With good safety function and prevent glass from breaking due to the effect of external force and shards spatter injury; With sound insulation, anti - ultraviolet function, can be made of color or high transparent film.

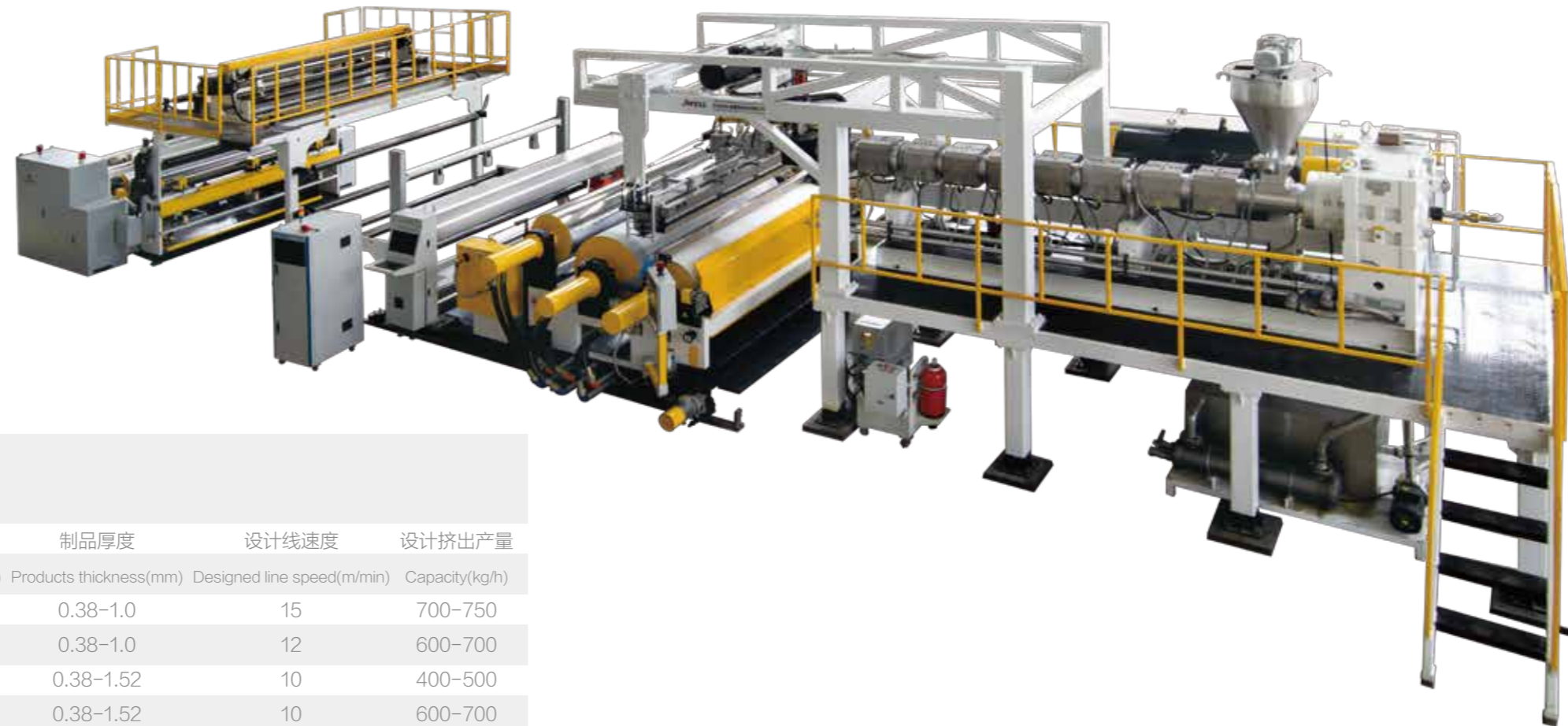

### 主要技术参数 Technical parameters

机型 Model	适用原料 Suitable material	制品宽度 Products width(mm)	制品厚度 Products thickness(mm)	设计线速度 Designed line speed(m/min)	设计挤出产量 Capacity(kg/h)
JWS120/150/120-2400	EVA/POE	2000-2400	0.38-1.0	15	700-750
JWS180-2400	EVA/POE	2000-2400	0.38-1.0	12	600-700
JWS150	PVB/SGP	2000-2600	0.38-1.52	10	400-500
JWE95-JWE65	PVB/SGP	2400-3000	0.38-1.52	10	600-700
JWE135-JWE95	PVB/SGP	3000-3600	0.38-1.52	20	1000-1200

注：以上所列资料仅供参考，可根据客户要求量身定制。  
Note: Informations listed above are for reference only, the production line can be designed by customer's requirements.

## LFT/CFP/FRP/CFRT连续纤维增强复合材料生产线 LFT/CFP/FRP/CFRT continuous fiber reinforced composite production line

连续纤维增强复合材料是由增强纤维材料：玻璃纤维(GF)、碳纤维(CF)、芳纶纤维(AF)、超高分子量聚乙烯纤维(UHMW-PE)、玄武岩纤维(BF)等，通过特有工艺技术使得高强度的连续纤维与热塑性、热固性树脂相互间浸渍，再经过挤压、牵伸等工艺形成的高强度、高韧性、可回收的新型热塑性复合材料；常用的树脂基体有PET、ABS、PP、PC、PA、PPS、POM等环保型热塑性材料。

Continuous fiber reinforced composite material is made of reinforced fiber material: glass fiber(GF), carbon fiber(CF), aramid fiber(AF), ultra high molecular polyethylene fiber(UHMW-PE), basalt fiber(BF) by using special process technology to makes high strength continuous fiber and thermal plastic&thermosetting resin soak with each other. Then extrusion and drawing process are used to form the high strength, high toughness and recyclable thermalplastic resin composite material .commonly used plastic are PET, ABS, PP, PC, PA, PPS, POM and other environmentally friendly thermoplastic materials.

产品应用：军工、航天、船舶、汽车轻量化、电子、风电、建筑、医疗、体育休闲等领域。

Product application: Military, spaceflight, ships, automotive light weight, electronics, wind and electricity, construction, medical, sports and leisure and other fields.



### 主要技术参数 Technical parameters

机型 Model	制品宽度 Products width(mm)	制品厚度 Products thickness(mm)	最大速度 Max.speed(m/min)
JWS-1800	1200-1600	0.1-0.8	12
JWS-3000	2000-2500	0.1-0.8	12

注：以上所列资料仅供参考，可根据客户要求量身定制。  
Note: Informations listed above are for reference only, the production line can be designed by customer' s requirements.



## PE石头纸生产线 PE Stone Paper Sheet Line

### 石头纸生产设备采用复合流/压延法生产工艺

配料、共混、挤出生产出专用母料，再经过挤出、压延、拉伸、冷却、表面处理、涂布、分切收卷即为原纸。生产效率高、产品质量好、生产成本较低、纸张表面光滑，特别适用于印刷高档画册及书籍封面等。

### Stone paper production equipments adopt casting&calendering process

compounding, mixing, extrusion to produce the special master batch, then through extruder, calendaring, stretching, cooling, surface treatment, coating, cutting and winding to produce origin paper. Its features for high efficiency, good quality, low cost production, smooth surface paper, especially used to print high grade album and book cover etc.

### 石头纸产品特性

石头纸生产工艺简单，高产出、能耗低；不采用植物纤维、不砍伐树木，可节省大量木材，保护自然生态；不需要添加强酸、强碱、漂白剂等化学原料，不排放废水、废渣和有毒有害气体，属于绿色环保产品。产品具有机械性能好、防水、防潮、防蛀、耐折、耐撕、耐油、无毒、无味、无污染、几何尺寸稳定、印刷清晰度高、效果好，用弃后可自然降解为粉末回归自然等特点，广泛应用于礼品包装、医药包装、办公用品、装饰画册等印刷制品领域。

### Stone paper features

Stone paper production process is easy, high output, lower power consumption; not use plant fiber、not cut trees, save lots of wood, protect natural environment; Don't need to add strong acid, strong alkali, bleaching agent etc. Chemical material, don't drainage waste water、waste residue and toxic and harmful air, that's green environmental product. Product with good mechanical performance、waterproof、moistureproof、moth-proofing, folding, tear resistant, oil resistant, non-toxic, tasteless, no pollution, stable geometry size, high printing resolution, good effect, can be natural degradation after with abandon for powder characteristics of return to nature, is widely used in gift packaging, pharmaceutical packaging, office supplies, decorative materials, and other areas of the printing products.



### 主要技术参数 Technical parameters

机型	制品宽度	制品厚度	最大挤出产量	拉伸倍率
Model	Products width(mm)	Products thickness(mm)	Max.extrusion capacity(kg/h)	Stretch ratio
JWS150+JWS90	1700	0.05-0.5	700-800	0-10
JWE75/44+JWE52/44	1700	0.05-0.5	400-500	0-10

注：以上所列资料仅供参考，可根据客户要求量身定制。  
Note: Informations listed above are for reference only, the production line can be designed by customer's requirements.

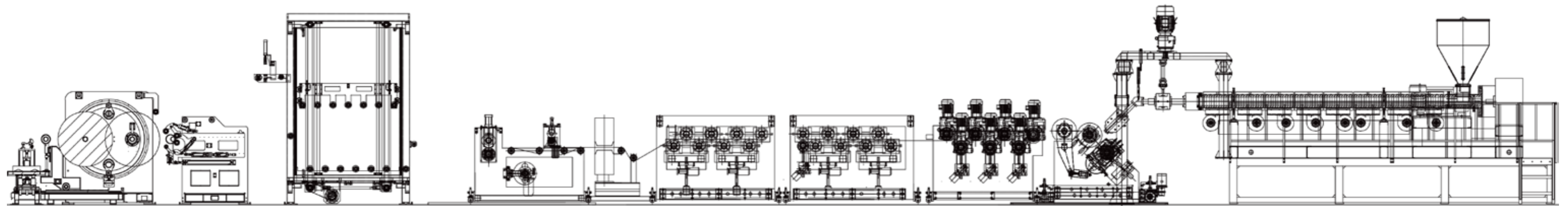

## TPO+PP发泡复合片材生产线 TPO+PP Foam Composite Sheet Production Line

金纬机械研制开发的TPO+PP发泡基材复合生产线，采用特殊结构的TPO螺杆，塑化均匀，结合独特的复合工艺，复合的产品粘强度高，无拉伸变形，无甲醛，是金纬公司针对汽车内饰材料领域推出的又一个国内领先的复合生产线，此复合材料具有操作灵活，复合效率高，对TPO表层纹路一次处理完成等优点，与基材一次热压成型复合的制品，完全颠覆了以往的复合方式，制品被广泛应用于高档汽车的内饰件，顶棚，管路等等。

It is successfully developed by Jwell Machinery, adopts special structure of TPO screw, plasticizing evenly, unique composite processing method, composite products have high bonding strength, No tensile deformation, formaldehyde-free, it is Jwell's company according to car interior materials's field recommends another domestic advanced composite sheet production line, this composite material has flexible operation, high efficiency of compositing, with the advantage to complete the treatment of the TPO surface layer's lines once time, with the basic material to hot pressing and compositing together once time, it is total different from past composite method, this product is widely applied in high class inner decoration, ceiling, pipe of the car, and so on.

### 主要技术参数 Technical parameters

机型 Model	JW100/33	JW120/33
复合厚度 Products thickness	0.5mm	0.5mm
制品宽度 Products width	1000mm	1500mm
最大挤出量 Max output capacity	120KG/h	220KG/h
主机功率 Main motor power	55KW	132KW

注：以上所列资料仅供参考，可根据客户要求量身定制。  
Note: Informations listed above are for reference only, the production line can be designed by customer's requirements.





## ASA薄膜生产线 ASA Film Extrusion Line

ASA薄膜是用聚氯乙烯、聚乙烯、聚丙烯、聚苯乙烯以及其他树脂制成的薄膜，用于包装,以及用作覆膜层。塑料包装及塑料包装产品在市场上所占的份额越来越大，特别是复合塑料软包装及建材表面包覆已经广泛应用。

The ASA film is made of PVC, polyethylene, polypropylene, polystyrene and other resins, used for packaging and for laminating. Plastic packaging and plastic packaging products are becoming more and more popular in the market, especially the composite plastic soft packaging and surface coating of building materials.

优点：ASA薄膜因其具有突出的抗老化性能，在屋面瓦领域应用广泛，在屋面瓦加工的同时，可以实现在线热复合，复合厚度均匀，无色差，粘结强度高，克服了传统的共挤ASA复合存在的色差问题，也节约了原料成本。

ASA表面的加工厚度范围：0.05-0.2mm，宽度1500mm，厚度均匀，尺寸稳定。

Advantage: Because of its outstanding anti-aging property, ASA film is widely used in roof tile field. In the process of roofing tile, it can achieve on-line thermal composite, with uniform thickness, no color difference and high bond strength. It overcomes the color difference of traditional coextrusion ASA composite, and also deals with the cost of raw materials.

The thickness of the ASA surface is 0.05-0.2mm, width 1500mm, uniform thickness and stable dimension.



### 主要技术参数 Technical parameters

机型 Model	JWS90-1500
适用原料 Material	ASA material
制品宽度 Products width	1400mm
制品厚度 Products thickness	0.05-0.15mm
挤出机规格 Extruder specification	JWS90/30
最大挤出量 Capacity (Max.)	150~180KG/H

注：以上所列资料仅供参考，可根据客户要求量身定制。  
Note: Informations listed above are for reference only, the production line can be designed by customer's requirements.



## 狭缝涂布模头 Slot Coating Dies

### 性能和优点

- 流料的预先计量减少了浪费，确保了幅宽方向上一致的涂布厚度，减少了挥发，是操作环境更加清洁；
- 流料的预计量减少了浪费，保证了在基材上不变的涂布厚度，并且允许泵与生产线速度同步；
- 精密的模头制造决定了其涂布厚度的一致性。
- 允许快速设定。
- 缩短了从开始涂布到制出满意产品之间的时间，因此提高了生产率并减少了浪费。
- 减少了涂布的可变因素，提高了生产过程的稳定性。
- 适用于范围广阔的各种涂布液、基材、涂布宽度。

### Performance and advantages

- The pre-metered system of fluid reduce the waste and make sure the uniform thickness on the direction of the width,reduce the volatilization and make the operate environment more clean.
- The pre-metered system of fluid reduce the waste and make sure the uniform thickness coating on the base materials and allowed the pump synchronous with the production speed.
- The precise slot coating die producing decided the uniform of the coating thickness.
- Allow the quick setup.
- Shorten the time between the beginning of the coating and manufacture the satisfactory products. So it improve the production rate and reduce the waste.
- Reduce the variable factor improve the stability when producing and repeatability.
- Suitable for wide range different kind of coating fluid,base materials,coating width and coating thickness.

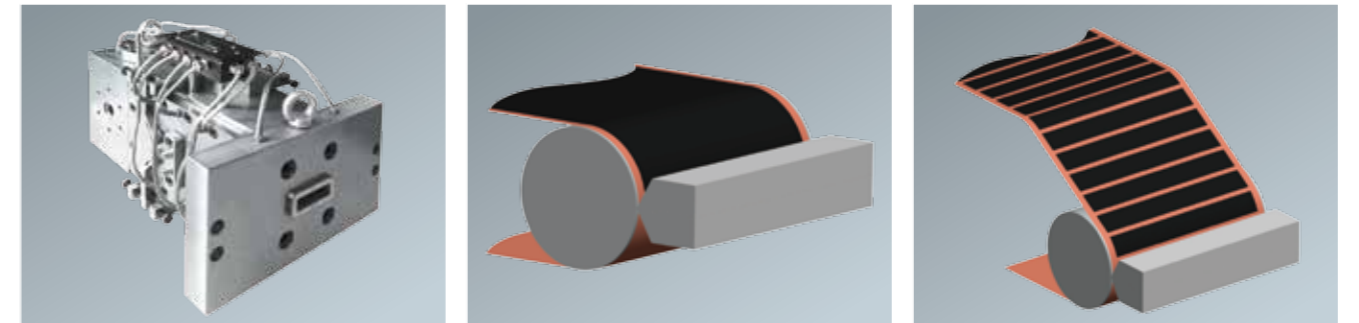

### 狭缝涂布模头应用领域/Applications

狭缝涂布模头可以生产出非常薄的涂层以及透明的光学涂层，同时可使涂层量保持在非常精确公差范围内，与将涂布液擦拭到基材上的涂布系统不同，我们的狭缝涂布模头属于模唇缝隙相对较大(可达到0.0762mm)的涂布模头，由此模唇缝隙抽吸出的液体可形成最薄至1  $\mu$  m的涂层。狭缝涂布模头可在涂层厚度只有0.002mm或者是2  $\mu$  m的情况下，将整个宽度上的涂层量控制在5%左右的公差变化范围内。我们生产的狭缝涂布模头模唇是固定的，因此可以利用可换的控隙片来改变涂层的厚度和宽度。涂布量从不足1  $\mu$  m到254  $\mu$  m的涂层厚度，该类模头可加工各种类型的胶粘剂(包括特殊的透明胶粘剂)电池、陶瓷电容器、装饰表面、电子显示介质、过滤膜、地板、燃料电池、磁性泥浆、医疗产品、光阻材料、压敏胶带、太阳能电池、超导体、撕带和窗用薄膜等。

Slot coating die can produce very thin and transparent optical coating layer. Meanwhile it can make the coating weight keep the very accurate tolerance range, it is different with the system which the coating fluid wiped on the base materials, our slot coating die is the die which die lip slot is relatively bigger( it can reach 0.0762mm). The coating fluid layer sucked from this die lip can be as thin as 1  $\mu$  m.

The slot coating die can control the coating weight tolerance in 5% in the whole width when the coating layer is only 0.002mm or 2  $\mu$  m. The slot die lip we manufacture is fixed so that it can control the coating layer thickness and width by using the replaceable shims. The coating layer thickness can be from less than 1  $\mu$  m to 254  $\mu$  m. This kind of slot die can make different kinds of adhesive (include the special transparent adhesive) battery, ceramic capacitor, decorate surface, Electronic display medium,filtering film, floor board, fuel battery, Magnetic mud,medical product, photoresist, pressure sensitive tape,solar battery,superconductor ,tear tape and film which used in the window.



## 薄膜模头系列 Film Die Series

此模头采用加长V水滴形流道,三角形分流技术以及特殊的稳流结构,有效提高各复合层的复合精度以及减少挤出过程中的‘M’形和‘W’形料流产生。上模唇采用推出式手动微调+自动微调一体式模唇,手动调节范围 $\pm 1\text{mm}$ ,自动调节范围 $\pm 300\ \mu\text{m}$ ;自动模唇调节控制部分我们采用的是目前非常先进的全闭环控制系统和自动测厚系统,使得产品的厚薄精度在 $\pm 2\%$ 以内,在线测厚仪在高频率不间断自动横向检测扫描,能够非常实时准确的显示制品的厚度公差。在线测厚仪检测数据经过电脑程序处理后,反馈给特殊的模唇热膨胀调节螺栓,实现对模唇的开口厚薄进行自动微调,快速有效的控制产品精度。并且我们的模头拥有良好的扩展性,可以根据客户的需求选配带除厚边装置的“内堵式宽度调节装置”或“外堵式宽度调节装置”,更好的满足客户生产多种宽幅产品的可能,实现更节约、更高效的生产。

该类模头适合与生产5000mm以下,厚度在0.06-0.18mm的CPP、PE、EVA、PVC、PET、PVB、PA等单层或多层薄膜。

The die head adopts an extension V shape water-drop type flow channel,with the shunt technology and special triangle stabilize structure. To composite layer and improve the precision of the extrusion process to eliminate 'M' shape and 'W' shape flow patterns effectively. The upper die lip using push-off type manual fine-tuning + automatic fine-tuning one-piece die lip, manual adjustment range is  $\pm 1\text{mm}$ , automatic adjustment range  $\pm 300\mu\text{m}$ ; About the automatic die lip adjustment control parts ,we use currently very advanced fully closed loop control system and the automatic gauging system makes the product thickness in  $\pm 2\%$  precisely, on-line thickness gauge is automatic continuous detecting scanning frequently, can shows the very real-time accurate thickness tolerance of the products. Through computer program processing the data, feedback to special die lip adjusting bolt thermal expansion, and to realize the opening of the die lip thickness for automatic fine-tuning, fast and effective control product thickness precisely. And we have good die head scalability, according to customers' needs , matching with different "inside blocking type width adjusting device" or "the outer blocking type width adjusting device", be better satisfied customer' s needs to more efficient production.

The die head suits for production under 5000mm,thickness between 0.06 -0.18 mm CPP, PE, EVA, PVC, PET, PVB, PA, single-layer or multilayer films.

### 自动流延膜模头 Auto-casting Film Die series



## 片材模头系列 Sheet Die Series

### JW-P-K1

快速开口系列模头，上模唇推拉式微调，柔性下模唇可实现不停机在线快速调整制品厚度规格，调节范围最大达5mm，带45度节流棒调节装置，适用生产PC、PS、PP、PE、PLA等单层或多层片板。

Fast opening die series, the upper die lip with fine-tuning push-pull type, the flexible lower die lip can adjusting product thickness on-line without stop, the Max adjusting range up to 5 mm, Equip with 45° blocking bar, it is suitable for produce PC, PS, PP, PE, PLA, single-layer or multi-layer plate.

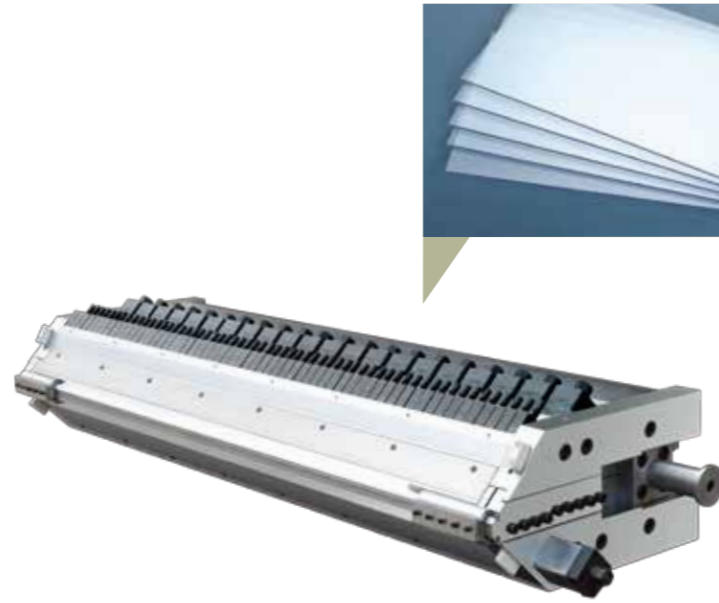

### JW-P-AT1

自动调节模头，上模唇含自动控制单元，分为手动调节和自动调节两部分，手动调节范围在1mm。自动调节范围在300um。适用PC、PS、PP、PE、PLA等不同宽度的单层、多层片材或薄膜。

Auto-adjusting die, the upper die lip is adjusted by the auto-control system which divided into manual-control unit and auto control unit; the first can control the accuracy in 1mm and the latter 300um. Fits for PC, PS, PP, PE, PLA single-layer or multi-layer sheet or film with different width.



### JW-P-A1

标准衣架式流道设计，上模唇可微调，适用生产PET(APET、PETG) PC、PS、PP、PLA等，单层或多层片板，宽度≤2100mm，厚度0.14-2mm。

With coat-hanger channel, micro-adjustable upper die lip, the die is perfect for single-layer or multi-layer PET(APET, PETG)PC, PS, PP, PLA plate with the width ≤2100mm, and the thickness between 0.14-2mm.



### JW-P-D1

模内复合模头，通过多流道模内复合，可有效提高各层面的薄厚精度。上模唇可微调、下模唇固定及芯层45度节流棒调节装置，适用生产PC、PS、PP、PE、PLA等多层共挤片材。

With multi-manifold design, the die can combine the materials inside to ensure the accuracy of the film. The die adopts micro-adjustable upper die lip, fixed lower lip and 45° blocking bar, which is fit for PC, PS, PP, PE, PLA multi-layer co-extrusion sheet.

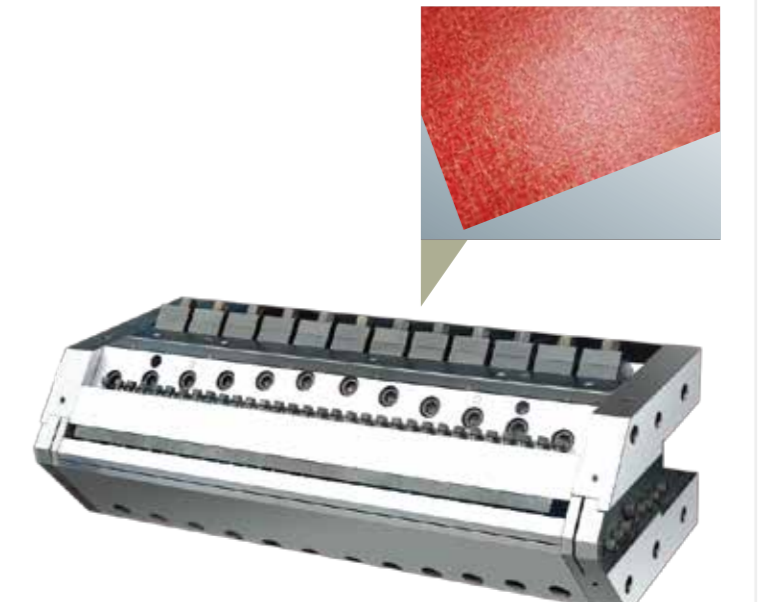



## 板材模头系列 Plate Die Series

### JW-B-A1

特殊衣架式流道设计，能最大限度上减少热敏性材料在挤出过程中的烧蚀。上唇可调、模唇可换及垂直节流棒调节装置，能满足不同厚度制品的需求。适用生产PVC自由发泡板材，制品厚度2-20mm。

With special coat-hanger channel design, the die minimizes ablation of heatsensitive material. With the adjustable upper die lip, changeable lower die lip and perpendicular blocking bar, the die meets the thickness requirements of various products. The die is fit for PVC foaming board with the thickness between 2-20mm.

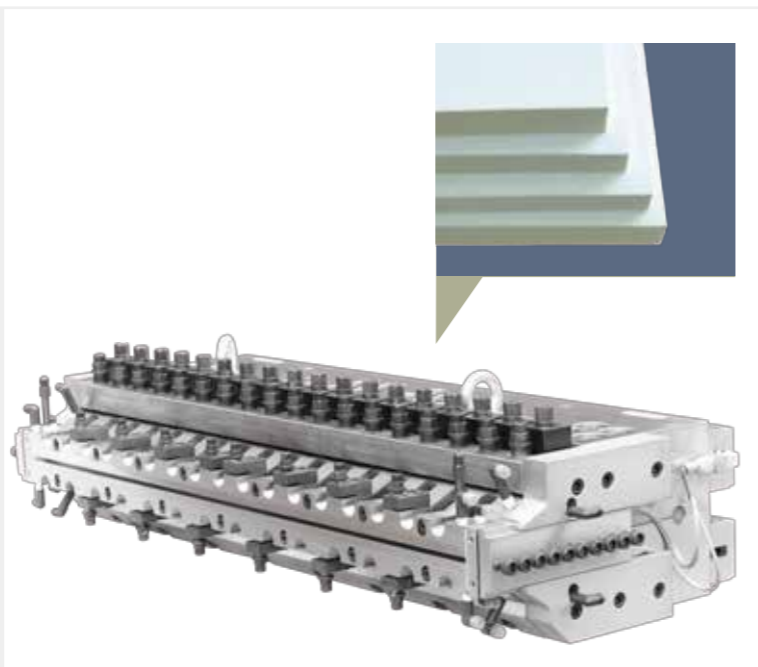

### JW-B-B1

标准衣架式流道设计，上模唇可调、下模唇可换及垂直节流棒调节装置。配ST型模唇挡块，能够在线快速调节制品宽幅。适用生产ABS、PS、PP单层或多层板材，制品厚度0.8-8mm。

The die adopts a typical coat-hanger channel, and adjustable upper die lip, changeable lower lip and perpendicular blocking bar. With ST-model width-control system, the width of products can be changed without interrupting. The die is designed for ABS, PS, PP single-layer or multi-layer plate with the thickness between 0.8-8mm.

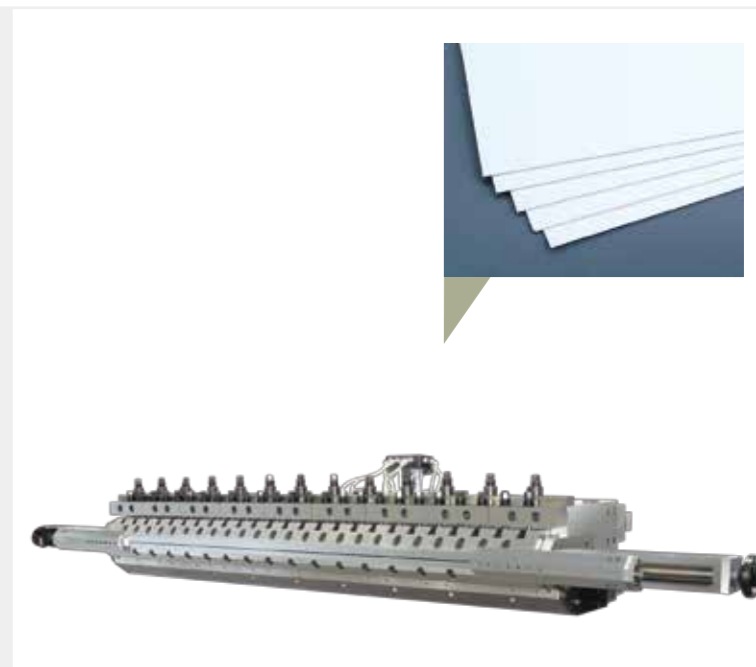

### JW-B-CF

采用双流道设计，上下模唇可调并带有模唇油温控制，所生产制品表面结皮效果好，内应力小，真正实现表面结皮发泡。制品厚度5-30mm。

Double flow channels design, the upper and lower die lips are adjustable with the oil temp control, the skinning effect of the products surface is better and have less inner stress, truly realizing surface skinning and foaming. Thickness of products: 5-30mm.



## PVC涂覆模头系列 PVC Coating Die Series

### JW-F-A1

PVC涂覆模采用特殊衣架式流道设计及独特的模唇结构，上模唇可调及垂直节流棒调节装置及涂层厚度可调，通过成对使用，可生产不同厚度、不同规格的专用运输带。该产品被广泛用与矿山，仓储，运输等场合；标准规格(mm): 650、800、1000、1200、1400、1600、1800、2000。

PVC coating die adopts special channel of coat-hanger structure, adjustable upper die lip, perpendicular blocking bar, the thickness of production can be adjusted. In pairs, special-purpose conveyor belt with different thickness and size can be produced. This kind of products are widely used in mining, storage, transportation and so on; Specification(mm): 650, 800, 1000, 1200, 1400, 1600, 1800, 2000.



## 多层共挤分配器 Multi-layer Co-extrusion Distributor

复合共挤分配器 适合各种聚合物料，配合挤出平模使用，可按照客户的分层要求，均匀地复合挤出成为薄膜、片材、板材制品。根据适用的塑胶原料和使用情况，有芯棒式、堵块式、摆叶式等形式可供选择，通过更换进料处的分层排序轴改变复合层的排列次序。可以处理的复合层数从2层到60层甚至更多。

Multi-layer co-extrusion feedblocks are suitable for various polymer plastic materials. Based on the customers' different requirements, a combination of T-die and co-extrusion feedblock provides the most competitive edge for film and sheet production. There are different modes of configuration for different features of plastic materials, layers which the feedblock can manage can reach 2 to 60 or even more.

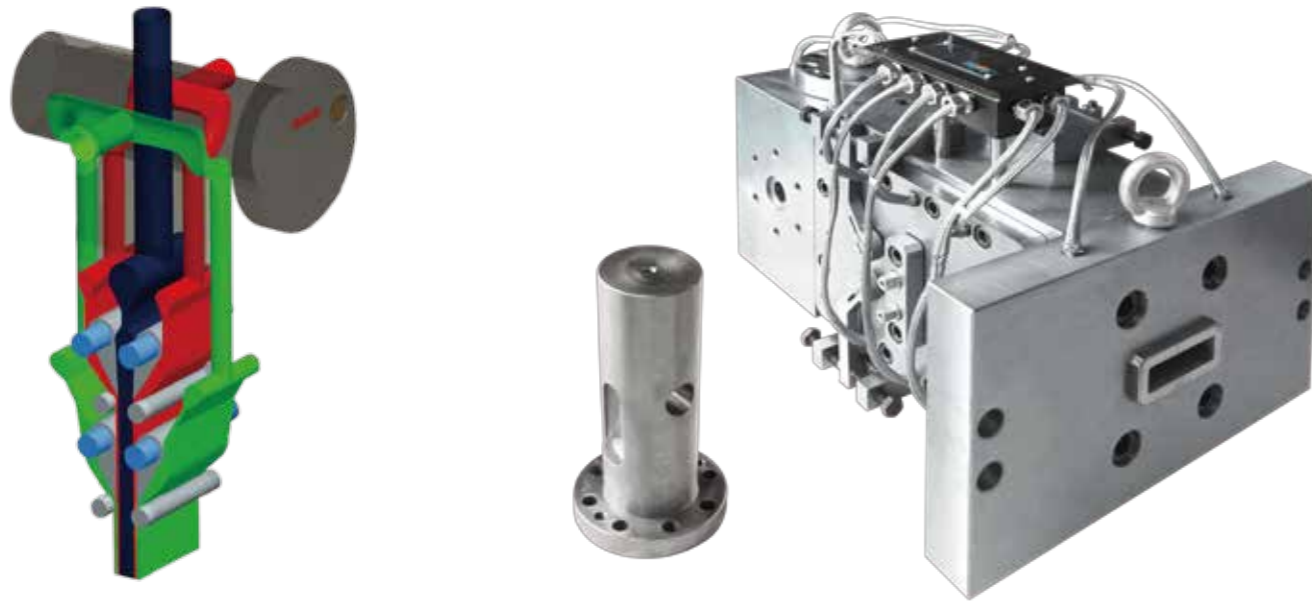

分配器结构图 Illustration of structure of distributor

原料排列方式 Materials feeding form					
流道模式 Running model					
应用实例 Materials feeding form	PS+HIPS EVA+PE PMMA+ABS ABS+HIPS APET+PETG	PS+HIPS+PS ABS+HIPS+ABS HIPS+HIPS+HIPS HIPS+PVC+HIPS PETG+APET+PETG	PMMA+HIPS+ABS PC+ABS+UPVC HIPS+HIPS+PS	PEPS+HIPS+PEPS+PS HIPS+HIPS+HIPS+PS	ABS+HIPS+HIPS+HIPS+ABS PMMA+ABS.PMMA +ABS+ABS.PMMA+PMMA

## 换网系统 Screen Changer System

JWELL生产的过滤换网系统广泛应用与各类塑料制品挤出、塑胶制粒等领域，完美的设计和精心的制作让产品的性能值得信赖；多种可供选择的规格型号，总有一款适合您的过滤要求。

JWELL's hydraulic screen changer system widespread use in all kinds of plastic products, plastic granulation etc, the perfect design and careful production let the product's performance is worth trust; A wide selection of structural form and specifications, always have a suitable for your requirements

### 手动换网器系列

- 挤出机螺杆可穿过换网器直接拔出，方便拆卸清理。
- 采用先进的压力密封技术，通过聚合物在网前的压力驱动密封元件，达到最佳密封效果，且换网更迅速。
- 模块化组合，适合不同标准挤出机，且清理方便。
- 低成本投资，适合小型挤出系统使用
- 最低的停留时间。
- 最小的安装空间，
- 适合不同的挤出产业。

### Manual screen changer series:

- Extruder screw can draw from the screen changer directly, it is convenient to remove and clean
- Adopts advanced pressure seal technology, through the pressure of polymers to drive seal components, to achieve the best sealing effect and change screen more quickly
- modular combinations, suitable for different standard extrusion machine, and convenient to clean
- Low cost investment, suitable for small extrusion system.
- The minimum stay time.
- The smallest installation space,
- Suitable for different extrusion industry.



### 主要技术参数 Technical parameters

型号	产量(Kg/h)	滤网规格 (mm)	过滤面积(mm <sup>2</sup> )	最高承压(Mpa)	温控分区	加热功率 (KW)
Model	Output	Filter size	Filtration area	Withstanding pressure	Heating zone	Heating power
JW-MT-50	50-100	Φ55	1960	20	2	3.3
JW-MT-70	80~150	Φ75	3850	20	2	3.3
JW-MT-100	150~350	Φ105	7850	15	2	6
JW-MT-120	250~400	Φ125	11300	15	2	8



## 液压换网系统 Hydraulic Screen Changer System

### 单柱液压换网器系列:

- 无机械密封结构, 保证在高压、高温状态下不渗料。有效降低换网阻力, 减小液压系统的工作压力。
- 一体式结构, 无承载缝隙, 强化承载压力, 使系统承载压力更高。
- 优质合金钢经氮化处理, 大幅延长产品使用周期。
- 整体式工程油缸, 使用寿命更长久。
- 经过流变优化后的蜂窝板, 有效降低了挤出过程中流体剪切。
- 采用内加热装置, 安全节能。全封闭走线, 美观大方。

### Single column hydraulic screen changer series:

- No mechanical seal structure, which can guarantee the high pressure and high temperature condition not seep materials. Effectively reduce the change screen resistance, reduce hydraulic system pressure of work.
- One-piece structure, without carrying aperture, strengthen bearing pressure, make the system load pressure is higher.
- Using High quality alloy steel, after nitriding process to extended product life span greatly.
- Integral engineering oil cylinder, a long use life.
- After optimization of rheological through cellular plate, to reduce the extrusion process fluid shear.
- Using inner heating device, for safe and energy-saving. Fully enclosed wires, for the elegant appearance.



### 主要技术参数 Technical parameters

型号 Model	产量(Kg/h) Output	滤网规格 (mm) Filter size	过滤面积(mm <sup>2</sup> ) Filtration area	最高承压(Mpa) Withstanding pressure	温控分区 Heating zone	加热功率 (KW) Heating power
JW-DZ-50	50~100	Φ55	1960	40	2	2.4
JW-DZ-70	80~150	Φ75	3850	30	2	2.4
JW-DZ-100	150~350	Φ105	7850	30	2	3.4
JW-DZ-120	250~400	Φ125	11300	25	2	6.4
JW-DZ-150	350~600	Φ155	17670	25	2	8
JW-DZ-180	450~1000	Φ185	25440	25	2	10



### 双柱双工位液压换网器系列:

- 无机械密封结构, 保证在高压、高温状态下不渗料。有效降低换网阻力, 减小液压系统的工作压力。
- 优质合金钢经氮化处理, 大幅延长产品使用周期。
- 整体式工程油缸, 使用寿命更长久。
- 交替式工作模式, 能保证在换网过程中的料流连续、稳定以及工艺参数的可重复性。
- 经过流变优化后的蜂窝板, 有效降低了挤出过程中流体剪切。
- 配合行程位置传感器, 换网更精确, 更可控。

### Double column with double working position hydraulic screen changer series:

- No mechanical seal structure, which can guarantee the high pressure and high temperature condition not seep material. Effectively reduce the change screen resistance, reduce hydraulic system work pressure .
- Using High quality alloy steel, after nitriding process to extended product life span greatly.
- Integral engineering oil cylinder, a long use life.
- Alternating work mode, can guarantee the material flow continuous, stability and the process parameters of repeatability, when change the screen
- After optimization of rheological through cellular plate, to reduce the extrusion process fluid shear.
- Cooperate with stroke position sensor, change the screen more accurate, more controllable.

### 主要技术参数 Technical parameters

型号 Model	产量(Kg/h) Output	滤网规格 (mm) Filter size	过滤面积(mm <sup>2</sup> ) Filtration area	最高承压(Mpa) Withstanding pressure	温控分区 Heating zone	加热功率 (KW) Heating power
JW-SZ-50	50~150	Φ55	1960X2	40	2	7.5
JW-SZ-70	80~150	Φ75	3850X2	40	2	7.5
JW-SZ-100	150~380	Φ105	7850X2	35	2	9
JW-SZ-120	350~700	Φ125	11300X2	30	2	13.5
JW-SZ-150	400~1000	Φ155	17670X2	28	2	15
JW-SZ-180	700~1500	Φ185	25440X2	25	2	18

## 液压换网系统 Hydraulic Screen Changer System

### 单板双工位液压换网器

- 挤出机螺杆可穿过换网器直接拔出，方便拆卸清理，
- 采用先进的压力密封技术，通过聚合物在网前的压力驱动密封元件，达到最佳密封效果，且换网更迅速。
- 穿透式螺栓与挤出机连接。
- 模块化组合，适合不同标准挤出机，且清理方便。
- 采用内加热装置，安全节能。全封闭走线，美观大方。

### Single-panel with double working position screen changer

- Extruder screw can draw from the screen changer directly, it is convenient to remove and clean,
- Adopts advanced pressure adaptive sealing technology, through the pressure of polymers to drive seal components, to achieve the best sealing effect and change screen more quickly.
- Penetrating type bolts connect the extruder.
- Modular combinations, suitable for different standard extrusion machine, and convenient to clean.
- Adopts the inner heating device, for safe and energy-saving. Fully enclosed wires, for elegant appearance.

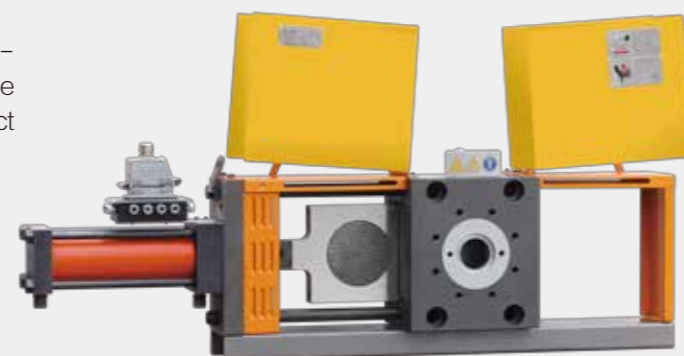

#### 主要技术参数 Technical parameters

型号	产量(Kg/h)	滤网规格 (mm)	过滤面积(mm <sup>2</sup> )	最高承压(Mpa)	温控分区	加热功率 (KW)
Model	Output	Filter size	Filtration area	Withstanding pressure	Heating zone	Heating power
JW-DB-50	50~100	Φ55	1960	30	2	5
JW-DB-70	80~150	Φ75	3850	30	2	6
JW-DB-100	150~350	Φ105	7850	30	3	6
JW-DB-120	250~400	Φ125	11300	30	3	6.4
JW-DB-150	350~600	Φ155	17670	25	3	7
JW-DB-180	450~1000	Φ185	25440	25	3	8
JW-DB-200	550~1300	Φ205	31415	20	3	12
JW-DB-250	850~1700	Φ255	49087	20	3	13
JW-DB-300	1100~2000	Φ305	70685	20	3	14

### 双板不停机液压换网器系列

- 采用先进的压力密封技术，通过聚合物在网前的压力驱动密封元件，达到最佳密封效果，且换网更迅速。
- 优质合金钢经氮化处理，大幅延长产品使用周期。
- 交替式工作模式，能保证在换网过程中的料流连续、稳定以及工艺参数的可重复性。
- 经过流变优化后的蜂窝板，有效降低了挤出过程中流体剪切。
- 采用内加热装置，安全节能。全封闭走线，美观大方。
- 模块化组合模式，适合不同标准挤出机，且清理方便。

### Double-panel hydraulic non-stop screen changer series

- Adopts advanced pressure seal technology, through the pressure of polymers to drive seal components, to achieve the best sealing effect and change screen more quickly.
- Using high grade alloy steel, after nitriding process to extended product life span greatly.
- Alternating work mode, can guarantee the material flow continuous, stability and the process parameters of repeatability, when change the screen.
- After optimization of rheological through cellular plate, to reduce the extrusion process fluid shear.
- Using inner heating device, for the safe and energy-saving. Fully enclosed wires, for the elegant appearance.
- Modular combination patterns, suitable for different standard extrusion machine, and convenient to clean.

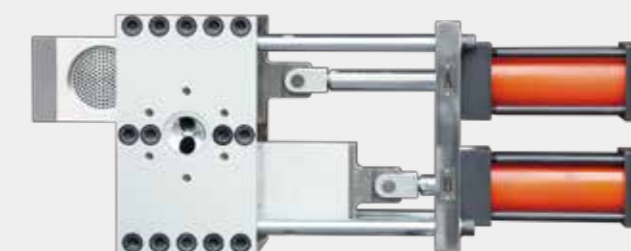

#### 主要技术参数 Technical parameters

型号	产量(Kg/h)	滤网规格 (mm)	过滤面积(mm <sup>2</sup> )	最高承压(Mpa)	温控分区	加热功率 (KW)
Model	Output	Filter size	Filtration area	Withstanding pressure	Heating zone	Heating power
JW-TB-50	50~100	Φ55	1960x2	30	4	18
JW-TB-70	80~150	Φ75	3850x2	30	4	18
JW-TB-100	150~380	Φ105	7850x2	30	6	18
JW-TB-120	350~700	Φ125	11300x2	30	6	20.4
JW-TB-150	400~1000	Φ155	17670x2	25	6	22
JW-TB-180	700~1300	Φ185	25440x2	25	6	27.2
JW-TB-200	850~1700	Φ205	31415x2	20	6	41.6
JW-TB-250	1100~2200	Φ255	49087x2	20	6	52
JW-TB-300	1500~2600	Φ305	70685x2	20	6	72



## 熔体计量泵 Plastic Melt Measuring Gear Pump

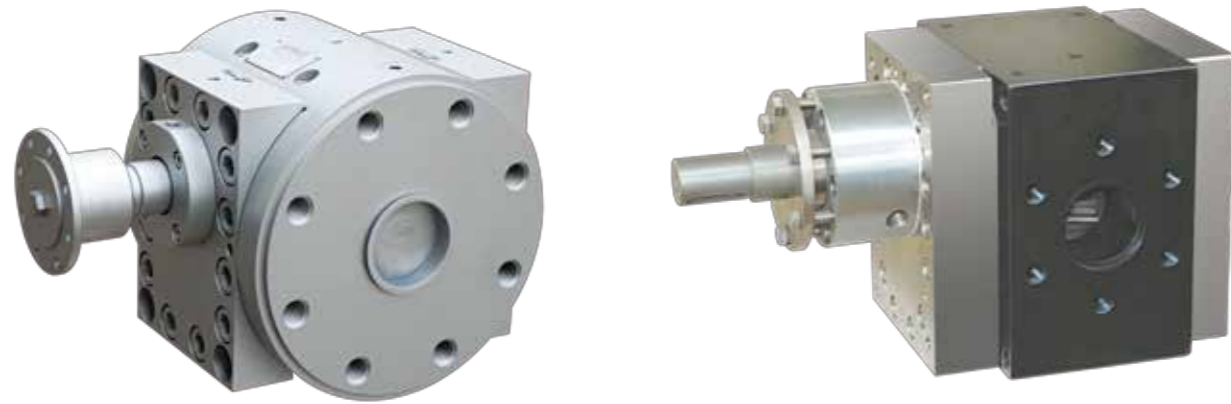

在挤出生产线上安装一台齿轮泵，通过泵前准确的测压，通过PLC调节挤出机速度，保持压力稳定、有序提供料流来优化供料过程。广泛用于如PC、PMMA、ABS、PET、PVB、PS、PP、PE等高低粘度物料的计量和增压。壳体采用优质合金钢制造，齿轮用淬硬的铬钢或其他优质金属材料制造，具有高效、防漏等优点。

Equipping a gear pump in front of the extruder, checking pressure before the pump and controlling the speed of extrusion, which can minimizing pulsation and irregular material feeding and ensures the polymer is smoothly extruded and continuously delivered to the die head. The system can be widely used to measuring and adding pressure for PC, PMMA, ABS, PET, PVB, PS, PP, PE. The shell of the pump adopts high-quality alloy-steel and the gear uses quenched chrome steel or other high-grade metallic materials which ensures high efficiency and leakage-proof.

### 主要技术参数 Technical parameters

型号 Model	排量(CC/r) Volume	转速(rpm) Round speed	产量(Kg/h) Output	传动功率(kw) Driving power
JW-30	30	20-100	30-150	3
JW-50	50	20-100	50-280	5.5
JW-100	100	20-95	110-500	7.5
JW-150	150	20-85	200-900	11
JW-250	250	20-70	300-1200	18.5
JW-400	400	20-70	400-1600	22

各种单层、多层共挤模头，适用PC、PMMA、APET、PETG、ABS、PS、HIPS、PVC、PP、PE、PU、PVDC等原料，选配不同类型的三辊压光机，可生产各种透明板、彩板、发泡板，中空阳光板、洁具板、铝塑复合板、防水卷材、专用地板革，以及各种食品、服装、医药等包装材料、文具片材、光膜、压纹膜、涂膜等。

We produce not only a variety of single-layer/multi-layer co-extrusion dies suitable for materials including PC, PMMA, AP-ET, PETG, ABS, PS, HIPS, PVC, PP, PE, PU, EVA, PVDC, but also other products such as high transparency panels, color panels, foaming sheet, hollow sunshine boards, sanitary ware sheet, aluminum-plastic composite panel, water-proof coils, special floor leather and various materials for food, clothes and medicine package, sheet materials for stationery, light film, graining film, coating film and so on.

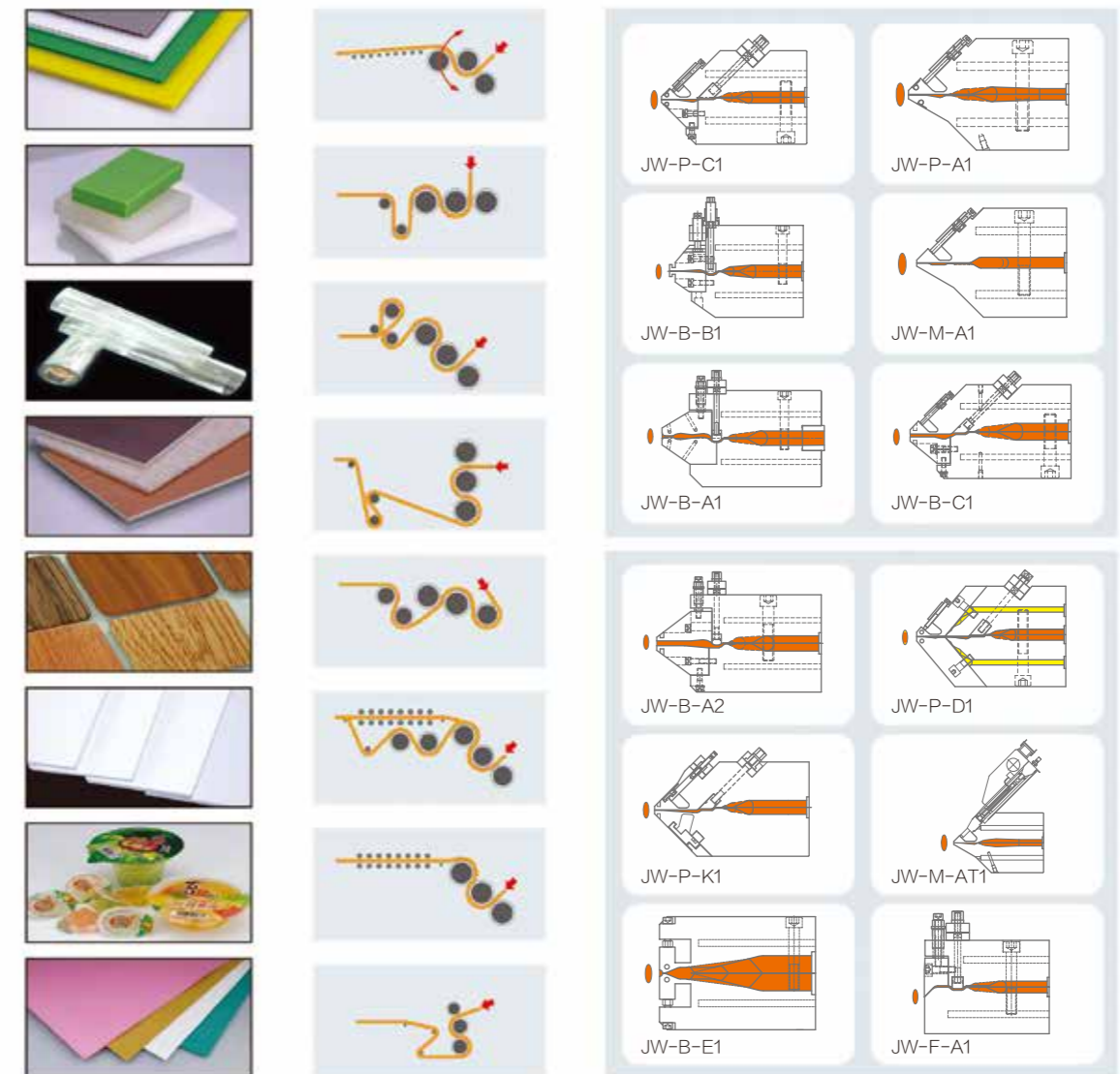

## 超级镜面辊 Super Mirror Roller

### 用于光学级板材、片板、薄膜制品

超级镜面对于光学级塑料板材、片材、薄膜生产设备来说是一个不可缺少的重要部件。其规律是：辊筒表面越光，越精密，生产出的制品质量就越好。因而，我们努力达到最小的表面粗糙度公差。

生产出的光学级制品主要应用于LED面板、电子、电器工业的薄膜开关；电脑、手机液晶显示屏等高端领域。

Super mirror surface roller is a key part of sheet and plate equipments. The rule is that the more smooth and precise the roller surface, the better the product quality. And, we always strike for the smallest possible surface roughness tolerance to the level of Ra0.005um.

The optics grade product is applied for producing LED panels, electronics, thin-film switch of electric appliances, and high end consumer products section like PC monitor, mobile phone screen and etc.

### 辊筒特点 Features

- 超镜面辊筒表面光洁度可以达到Ra0.005-0.01  $\mu\text{m}$ ;
- 辊筒的圆柱度、同轴度均达到 $\leq 0.005\text{mm}$ ;
- 特殊的结构设计以保障极强的辊筒刚性和表面温度误差最小;
- The surface roughness level of the roller can be reached Ra0.005-0.01  $\mu\text{m}$ ;
- He ( the ) cylindricity and cocentricity of the roller can be reached  $\leq 0.005\text{mm}$ ;
- Enhanced roller rigidity and minimized roller surface temperature deviation through special roller structure design.

## 精密花纹辊筒 Embossing Roller

花纹辊用于PMMA、PC 板材、PP 片等多种塑料片、板材的表面成型处理。辊面可以加工成各种花纹形式，采用激光电子扫描与分色技术，将客户来样图像转化成高清晰度数字影像信息直接录入雕刻机复制雕刻出高质量的辊面花纹。辊面花纹的仿真率高达98%以上。

在辊筒表面进行喷砂处理，按照目数的大小，使辊筒表面达到消光、亚光及雾面和毛面的效果。制品应用于灯具、装潢、皮革、汽车等多种领域。

Embossing roller is used for surface treatment of plastic sheets and boards like PMMA, PC, PP and etc. Roller surface can be processed into a variety of decorative patterns. The sample image will be converted into high resolution digital image information with laser scanning electron and color separation technology and then loaded directly into the carving machine, and high quality roller surface pattern will be carved out by the carving machine. The roller surface pattern simulation rate is above 98%.

Sandblasting processing is applied to the roller surface. According to the size of the mesh, the roller surface to will have the effect of dull, matt, mist, and rough effect.

Products applied to the various fields like lighting appliances, decoration, leather products, automotive and so on.

### 辊筒特点 Features

- 辊面材料可采用45钢、38GrMoAl、42GrMo、60GrMoV等;
- 多种内部流道设计，辊面温度均匀，确保制品表面花型的均匀一致;
- 表面电镀层硬度达到HRC60-62，延长花纹辊的使用寿命。
- Roller surface material includes 45 # steel, 38GrMoAl、42GrMo、60GrMoV, and etc;
- Both the diversified internal runner design, and the roll surface temperature uniformity technology, ensure the uniformed pattern on the product surface;
- Surface plating hardness can be reached HRC60-62, prolong the service life of the embossing roller.





## 电磁加热辊筒 Electromagnetic Heating Roller

由于加热辊在各行业应用广泛，电磁加热辊正取代导热油加热辊，目前在激光防伪印刷、模压、汽车夹层玻璃复合、复合膜生产、医用胶带、药品包装、非织造无纺布生产、铝塑板胶合、化学合成纤维、橡塑压延等行业成功应用。

With the wide application of heating roller in various industries, electromagnetic heating roller is replacing heat conduction oil heating roller, so far electromagnetic heating roller is successfully used in laser anti-counterfeiting printing, die stamping, automotive laminated glass composite, composite film production, medical tape, pharmaceutical packaging, non-woven fabric production, aluminum-plastic panel agglutination, synthetic fiber, rubber and plastic calendaring and other industries.

### 辊筒特点 Features

- 节能——比导热油辊或蒸汽辊节能约60%；
  - 温控精度高——温控精度达  $\pm 0.5^{\circ}\text{C}$  ；
  - 升温速度快——从室温到200 $^{\circ}\text{C}$  只需25min；
  - 工作温度高——辊面工作温度可实现400 $^{\circ}\text{C}$  以上，满足高温生产要求；
  - 环保——全电气化控制，无油渍污染，生产环境清洁卫生。
- energy saving - 60% energy saving comparing with the heat conduction oil roller or steam roller;
  - high precision temperature control, temperature precision reaches  $\pm 0.5^{\circ}\text{C}$  ;
  - faster heating up- takes only 25 min from room temperature to 200  $^{\circ}\text{C}$  ;
  - high working temperature, roller surface temperature can reach above 400  $^{\circ}\text{C}$  for operation , satisfies the requirement of high temperature production;
  - environmental protection - all electric control, no oil pollution, clean production environment.

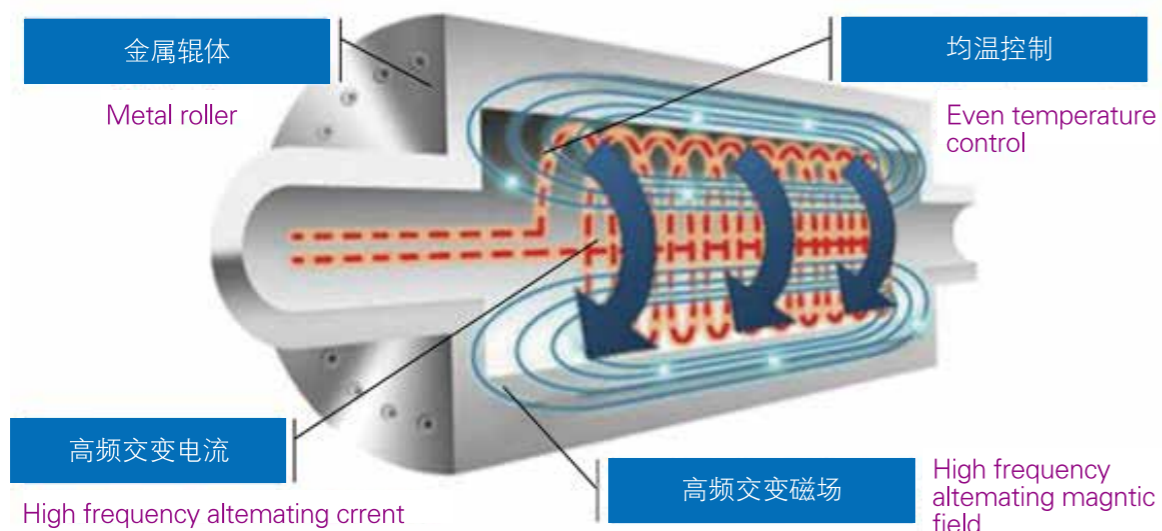

## 光学膜用途微结构辊 Micro-Structure Roller for Optical Film & Sheet

微结构辊经过在辊面镀铜、镀镍以后进行辊面微结构处理，制成高等级的光学片材或薄膜，成为LED/LCD面板的关键模块组件。制品应用于制作于LCD/LED背光的光学膜，棱镜片增光膜（prism）和微透镜膜（micro lens），3D光栅膜，液晶显示屏、笔记本电脑、移动电话等领域。

Microstructure roller make the micro structure treat for the roller surface after the copperize, nickelage, to be the height class optics sheet or film which will be the key module parts of the LCD panel. The final product used in the LCD/LED display, mobile phone, 3D raster, prismatic lens and micro lens.

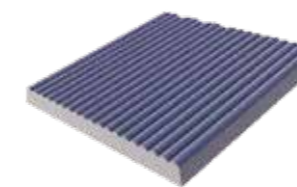
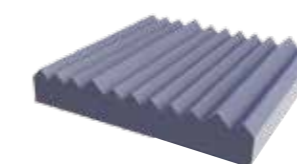
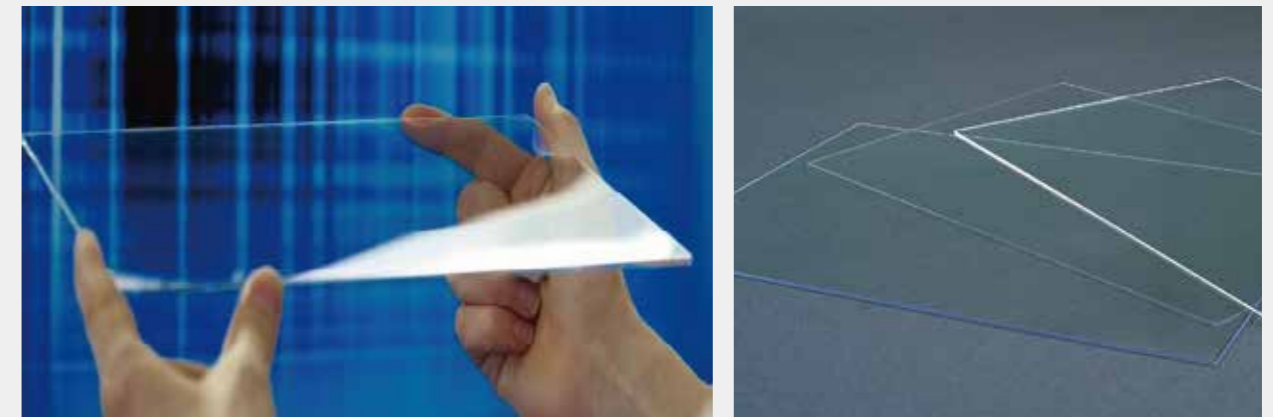

## 流延膜用辊筒 Casting Film Roller

JWELL制造的流延膜用辊筒采用严格的欧洲专业制造标准，经过多道焊接和热处理工艺，保证辊筒的整体结构坚固可靠。

为了确保其高效的热交换效果，流延辊筒的流道均为特殊的螺旋形设计，并对通过流道的冷却液流量进行精确的计算，从而尽可能的减小辊筒表面温度误差，提高了产品的温度均匀性。

流延膜用辊筒的动平衡精度尤为重要。专用的大型动平衡校验设备和多种平衡检测方案，使其在高转速下运行平稳。

JWELL manufactured casting film roller strictly according to European professional manufacturing standards. Several steps of welding and heat treatment process are applied to give ensurance to the overall rigidity and reliability of roller structure.

In order to ensure its efficient heat exchange, casting roller flow channel are designed with the special spiral, and through accurate calculation of the coolant flow, the roller surface temperature deviation are reduced to the least possible. It improves the temperature uniformity of the product.

The most important is the precision of dynamic balancing of roller. Specialized large dynamic balance calibration equipment and a variety of balance detection scheme, ensures smooth operation at high rotation speed.



较高的生产线速度要求流延膜用辊筒具有极高的转速、精确的动平衡精度、快速均衡的热交换效率；

High speed of casting film production line means very high rotation speed of the roller, and this requires precise dynamic balancing, high and balanced heat exchange efficiency;

### 辊筒特点 Features

- 最大的辊筒直径：Φ1600mm
- 辊筒的圆柱度、同轴度均达到 $\leq 0.005\text{mm}$ ；
- 辊筒表面镀硬铬，镀层厚度50~80um
- 辊筒表面温度误差 $\pm 0.5\sim 1^\circ\text{C}$ ；
- 表面抛光镜面、超精镜面、毛面/雾面、防粘辊面处理；
- 运行速度：最大800米/分；
- 整体变形：全负荷时 $< 0.05\text{毫米}$
- 运行时动平衡 最佳 $Q=3.2$

- Roller diameter: max. 1600 mm
- Roller cylindricity, concentricity both  $\leq 0.005\text{mm}$ ;
- Roller surface hard chromium plated, coating thickness is 50 ~ 80 um
- Roller surface temperature deviation  $\pm 0.5\sim 1^\circ\text{C}$ ;
- roller surface treatment: mirror polished, super finishing mirror, matt, mist and anti adhesive surface;
- Speed: max. 800 m/min;
- Overall deformation:  $< 0.05\text{ mm}$  at full load
- Best dynamic balance:  $Q = 3.2$





## 挤出机械物联网+智能制造解决方案

工业4.0时代的互联—CPS（信息物理系统cyber physical systems），不是简单的对互联网、物联网、传感网的替代，它是信息世界和物理世界的深度融合。

未来挤出装备不再是一个孤立的自动化、信息化孤岛，未来的挤出机工厂会通过云平台与整个供需体系形成灵活智能的产品制造网络。工业4.0背景下的智能注塑发展趋势，多品种小批量快周期的定制化生产；多种生产技术和工艺的高度集成化；少人或无人状态下的自主生产过程；从原料到成品整个过程的信息化管理……

The interconnected in the industrial 4.0—CPS (cyber physical systems) is not a simple alternative to the Internet, the Internet of things, and the sensing network. It is a deep integration of the information and the physical.

The future extrusion equipment is no longer an isolated automation and information island. The future extruder factory will form a flexible and intelligent product manufacturing network through the cloud platform and the whole supply and demand system. In the industrial 4.0 background, the development trend of intelligent extrusion, customized production of multi variety and small batch fast cycle; High integration of various production techniques and processes; autonomous production process under less people or unmanned state; information management from the whole process of raw material to finished product...

在朝着工业4.0发展的过程中，我们的设备更智能化了！金纬机械智能化生产线：

- 1.可以监测主机电流。
- 2.可以监测主机温度。
- 3.可以监测主机电能。
- 4.可以监测主机每吨物料能耗（目前仅支持有米重控制的设备）。
- 5.可以在手机上查看数据信息。
- 6.可以记录并统计设备故障，部件更换等信息。
- 7.可以连接MES系统。
- 8.可以远程调试程序。

In the process of industrial 4.0, our equipment is more intelligent! Intelligent production line of Jwell:

1. can monitor the current of the extruder.
2. can monitor the temperature of the extruder.
3. can monitor the power of the extruder.
- 4., the energy consumption per ton of material can be monitored. (At present, only equipment with rice weight control is supported)
5. you can view the data on the phone.
6. records and statistics of equipment failure, parts replacement and other information can be recorded and counted.
7. can connect the MES system.
8. the program can be debugged remotely.



实时工况  
Real-time operating status



作业情况统计  
Working status statistics

## Plastic Machinery Fully Integrated Automation & Internet Of Things Control System Solutions

基于MES系统平台，实现车间生产管理的信息沟通平台，并向智能化方向发展。

Based on the MES system platform, the information communication platform of workshop production management is realized and move toward the intelligent direction



## 企业风采：品质管理 技术研发 国际交流 客户服务 员工培训



## Quality Control Technology Research International Communication Customer Service Staff Training



# 名片



24小时服务  
24 Hours Service



客户服务热线  
Customer Service Hotline



培训  
Training



交钥匙工程  
Turn-Key Project